

↓
**Medium Voltage Switchgear
and Switches**



→ **Medium Voltage Switchgear up to 17.5 kV,
Air-insulated, metal-clad,
withdrawable technique**

Type: AMC

Medium-voltage switchgear up to 17.5 kV, air-insulated, metal-clad, withdrawable technique, Type AMC

Index

Main features	4	Delivery programme bus sectionaliser riser panel	26
Requirements	5	Equipment for bus sectionaliser riser panel	27
Application examples	5	Delivery programme busbar riser panel; with cable connection	28
Economic efficiency	5	Equipment for busbar riser panel; with cable connection	29
Reliability of supply	5	Delivery programme busbar earthing panel	30
Personnel safety	5	Equipment for busbar earthing panel	31
Panel structure	6	Delivery programme contactor panel	32
Panel design	6	Equipment for contactor panel	33
Pressure relief	6	Drawer unit delivery programme/equipment	
Configuration of the drawer unit compartment	6	Delivery programme vacuum circuit-breaker drawer unit	34
Configuration of the busbar compartment	6	Equipment for vacuum circuit-breaker drawer unit	35
Configuration of the cable connection compartment	6	Delivery programme vacuum load-break switch drawer unit	36
Configuration of low voltage compartment	6	Equipment for vacuum load-break switch drawer unit	37
Equipment	7	Delivery programme disconnecting link drawer unit	38
Current and voltage transformers	7	Equipment for disconnecting link drawer unit	39
Capacitive voltage detection systems	7	Delivery programme vacuum contactor drawer unit	40
Door interlocking	7	Equipment for vacuum contactor drawer unit	41
Cable installation	7	Delivery programme earthing switch	42
Cable clamps	7	Earthing switch, type EDL	42
Panel wiring	7	Earthing switch type DES	42
Panel configuration	8	Equipment for earthing switch	43
Basic panel structure	8	Installation in the switchgear room	44
Key to type references	9	Operating premises and intended use	44
Type reference key of panels	9	Equipment installation in the switchgear room	44
Type reference key for AMC drawer units	9	Personnel safety	44
Operation/interlocking	10	Vacuum circuit-breaker	45
Operation at the panel	10	Type NVL vacuum circuit-breaker	45
Interlocking system	10	Switch poles	45
Technical data/standards	11	Switch mechanism	45
Technical data for AMC panels	11	Capacitive voltage detection system	46
Standards	11	Capacitive voltage detection system	46
Panel delivery programme/equipment		Switchgear accessories	47
Delivery programme circuit-breaker panel	12	Busbar earthing drawer unit	47
Equipment for circuit-breaker panel	13	Auxiliary carriage	47
Delivery programme load-break switch panel	14	Operating levers	47
Equipment for load-break switch panel	15	Protection technology	48
Delivery programme load-break switch panel with HRC fuse base	16		
Equipment for load-break switch panel with HRC fuse base	17		
Delivery programme bus sectionaliser circuit-breaker panel	18		
Equipment for bus sectionaliser circuit-breaker panel	19		
Delivery programme metering panel M1; sectionaliser panel	20		
Equipment for metering panel M1; sectionaliser panel	21		
Delivery programme metering panel M5; with outgoing cables	22		
Equipment for metering panel M5; with outgoing cables	23		
Delivery programme metering panel M6; busbar voltage measurement	24		
Equipment for metering panel M6; busbar voltage measurement	25		

Medium-voltage switchgear up to 17.5 kV, air-insulated, metal-clad, withdrawable technique, Type AMC

Main features

Main features

AMC (Air-insulated Metal Clad) panels are type-tested, air-insulated, metal-clad units which can be assembled side-by-side.

Ormazabal AMC switchgear assemblies satisfy the international requirements for air-insulated metal-clad switchgear assemblies.

- ✓ Switchgear in withdrawable technique
- ✓ Four metal-clad compartments
- ✓ Drawer units with vacuum circuit-breaker
- ✓ Drawer units with vacuum load-break switch
- ✓ Drawer units with vacuum contactor
- ✓ Standard current and voltage transformers
- ✓ All standard types of protection and control systems can be used
- ✓ Suitable for combined protection and control systems, as well as for inclusion in network control systems
- ✓ Cable connection compartment with separate access door at the front and clamps for up to 6 cables per phase
- ✓ High reliability
- ✓ High security of supply
- ✓ Maximum personnel safety
- ✓ High operator safety
- ✓ Low-maintenance switchgear
- ✓ Simple and clear operation
- ✓ Options for customer-specific equipment
- ✓ Simple and robust design
- ✓ Easy-to-install panel structure



Medium-voltage switchgear up to 17.5 kV, air-insulated, metal-clad, withdrawable technique, Type AMC Requirements

Requirements

Application examples

AMC switchgear is suitable for use in switching stations for power generation and power distribution for:

- Utility companies
- Combined heat and power stations
- Power distribution at buildings
- Steel industry
- Heavy industry
- Airport power distribution systems
- Automotive industry
- Chemical industry
- Petro-chemical industry
- Food industry
- Main distribution substations
- Shipbuilding
- Stand-by generating supplies



Application example in the chemical industry

Economic efficiency

The flexibility of the standardised AMC switchgear with its options for configuration to customer requirements allows it to be functionally matched to its application. The panels can be extended or modified at a later date after installation. The grouped panels can be extended on either side without modification to the existing installation.

Reliability of supply

The high quality of AMC switchgear with separate compartments for busbars, switchgear and cable connections ensures a high degree of reliability in operation and supply for the application. Thus, for instance, cables can be checked or switchgear exchanged without switching off the busbars, with the overall equipment remaining in operation. The drawer unit design allows the operating parts of the equipment to be restored to availability within the shortest possible time.

Personnel safety

In general all switching operations are performed with closed panel doors.

The panels have been tested for arc faults according to IEC 62271-200 and thus satisfy the international standards for the personnel safety in the event of an internal fault. Metal doors, shields and positively actuated shutters in the drawer unit compartment protect against unintentional touching of energised parts.

An extensive interlocking system for the switchgear and the panel offers the operator additional protection against incorrect actuation.

Voltage testing in the individual compartments can optionally be performed using capacitive systems to IEC 61243-5. This can be done without opening the compartment doors.

Medium-voltage switchgear up to 17.5 kV, air-insulated, metal-clad, withdrawable technique, Type AMC

Panel structure

Panel structure

Panel design

AMC switchgear is characterised by its type-tested panels which can be extended on either side. The interior structure is divided into three medium-voltage metal-clad compartments.

A = drawer unit compartment

B = busbar compartment

C = cable connection compartment

The low voltage compartment (relay enclosure) is arranged as a separate module partitioned with sheet-metal and can optionally be supplied at various heights. To facilitate transport into the switchgear room, the low voltage compartment can be detached from the switchgear panel. Connections between the panels are brought through the sheet-metal by insulated cast resin bushings. The cabinets are made of galvanized sheet steel in a solid, distortion-resistant construction. The panel doors are powder-coated in RAL7035.

The several abscission, insulation and operating components are bolted or riveted to the panels depending on the requirements. The panel front has separate compartment doors hinged on the right for the drawer unit compartment, cable connection compartment and low voltage compartment. The door opening angle is restricted to about 150 degrees to ensure the means of escape.

An existing installation can be extended on both sides using factory-built standard units.

Pressure relief

All medium voltage metal-clad compartments have separate pressure relief facilities. In the standard version, the pressure relief from the switchgear panel is directed upwards.

Depending on the application and the switchgear building pressure relief facilities, arc absorber assemblies for pressure reduction can be fitted instead of pressure relief flaps; or a pressure relief channel can be mounted, which can be arranged panel-wise with lateral connecting flange depending on the design of the panel. A closed panel floor is an essential feature of the type-tested standard equipment.

Configuration of the drawer unit compartment

Depending on the panel type, the drawer unit compartment can be equipped with the following units:

- Vacuum circuit-breaker
- Vacuum load-break switch
- Vacuum contactor (incl. HRC fuse base)
- Disconnecting link
- Busbar earthing switch

Positively actuated metal shutters protect against unintentional touching of the fixed contacts when the drawer unit is in the disconnected position. An auxiliary carriage is available for taking out and inserting the drawer unit; the carriage is interlocked with the panel while handling.

Mechanical actuation of the switches and operation of the drawer units when the metal-clad compartment is closed is provided by actuating controls at the compartment door.

Optional motorised drives for the switches and the drawer movement are available so that fully remote control can be implemented. Optionally, in the metering panel current and voltage transformers according to DIN 42600 part 8 respectively part 9 can be fixed mounted instead of the drawer unit. In the bus sectionaliser riser panel versions the compartment can remain unequipped without bushings and shutters.

Configuration of the busbar compartment

The busbar compartment is equipped with flat copper busbars sized according to the panel rating. The busbars can be linked from panel to panel. Inside, the busbars are mounted phase-wise on insulators, so that panels can be easily and quickly assembled into a row. The busbar supports can optionally be assembled with a capacitive system for voltage measuring according to IEC 61243-5. The partitioning of the busbar compartment is provided with bushings for panel-to-panel connections.

Configuration of the cable connection compartment

The cable connection compartment offers a multitude of standard and customer option equipment with:

- Current and voltage transformers
- Voltage transformers with primary fuses
- Earthing switch
- Surge arrester
- Three-phase medium voltage capacitor
- HRC fuse base

Depending on the panel version up to three cable systems per phase can be connected in AMC6 panels and up to six cable systems per phase in AMC9 panels. The panel floor is sheet-metal. In the bus sectionaliser panel versions, the compartment contains the section busbars. For connections through the side, flat profile copper busbars are used as in the busbar compartment. Inside, the busbars are mounted phase-wise on insulators, so that panels can be easily and quickly assembled into a row.

Optionally, a capacitive system for voltage measuring according to IEC 61243-5 can be mounted in the busbar compartment.

Configuration of low voltage compartment (relay enclosure)

The low voltage compartment is designed as a separate assembly and can be removed from the switchgear panel. The configuration with protection and control systems is arranged functionally for the respective application. Application-related standards such as those for outgoing panels with overcurrent protection, differential protection, motor protection etc. provide a secure project planning basis for the consultant.

All usual protection and control systems can be assembled. Also equipment supplied by the customer can be used.

Medium-voltage switchgear up to 17.5 kV, air-insulated, metal-clad, withdrawable technique, Type AMC Equipment

Equipment

Current and voltage transformers

For configurations with current and voltage transformers, Ormazabal use proven international technology. As standard, current and voltage transformers according to DIN 42600, parts 8 and 9, and IEC 60044-1 will be mounted. In addition, because of the multitude of installation options in the cable connection area, a wide variety of transformers supplied by the customer can be used. The current and voltage transformers are mounted as separate assemblies, irrespective to the basic panel design and functional elements such as the contact systems for the drawer units and earthing switches. Depending on the panel equipment and type, they can be exchanged, protected by the metal partitioning, even while operating busbar compartment. The standards and generally recognised technical rules (IEC standards, DIN standards, VDE regulations) for working on medium voltage installations must be observed.

Capacitive voltage detection systems

The optional capacitive voltage detection system according to IEC 61243-5 is mounted in the cable connection and/or busbar compartment of the panel. It is assembled irrespective of the basic panel design and functional elements. It can be exchanged under the same conditions as previously described for the current and voltage transformers.

Door interlocking

The doors can optionally be equipped with mechanical and electro-mechanical interlocking.



Panel type AMC9-12/2500-2500/31-L cable connection area with 6x1x500mm² per phase and capacitive insulators

Cable installation

The medium voltage cables can be installed from the front of the panel. The cable connection compartment is easily accessible and has a separate compartment door. After the drawer unit has been removed out of the panel, the front cross-spar of the panel and the plate between the drawer unit compartment and cable connection compartment can be removed with a few movements, for additional ease of installation of cables in the cable connection compartment.

The maximum cable cross-sections that can be attached at the cable connections at the panels are as follows:

AMC6 = maximum 3 single-core cables 240 mm² per phase

AMC9 = maximum 6 single-core cables 500 mm² per phase

The panel floor comprises of split sheet metal modules with reducing rings for sealing the incoming cables.

Cable clamps

The short circuit-proof cable mountings in the switchgear panel are provided in the cable connection compartment by means of cable fixing irons and cable clamps. There are two cable clamp sizes available for installation.

Size 1

Cable clamping range for single-core cables 26 to 38 mm diameter

Size 2

Cable clamping range for single-core cables 36 to 49 mm diameter

Panel wiring

Control wiring within the panels is installed in generously-proportioned metal wiring ducts, which are easily accessible to the left and right of the front interior of the panel. In all panel variants the left wiring duct extends from the panel floor up to the low voltage compartment, enabling separate wiring possibilities for each switchgear panel. Additionally, in the low voltage compartment area there are side openings which allow connections from panel to panel to a loop wiring system.



Standard voltage transformers DIN 42600 part 9, front mounted

Medium-voltage switchgear up to 17.5 kV, air-insulated, metal-clad, withdrawable technique, Type AMC

Panel configuration

Panel configuration

Basic panel structure (configuration example)

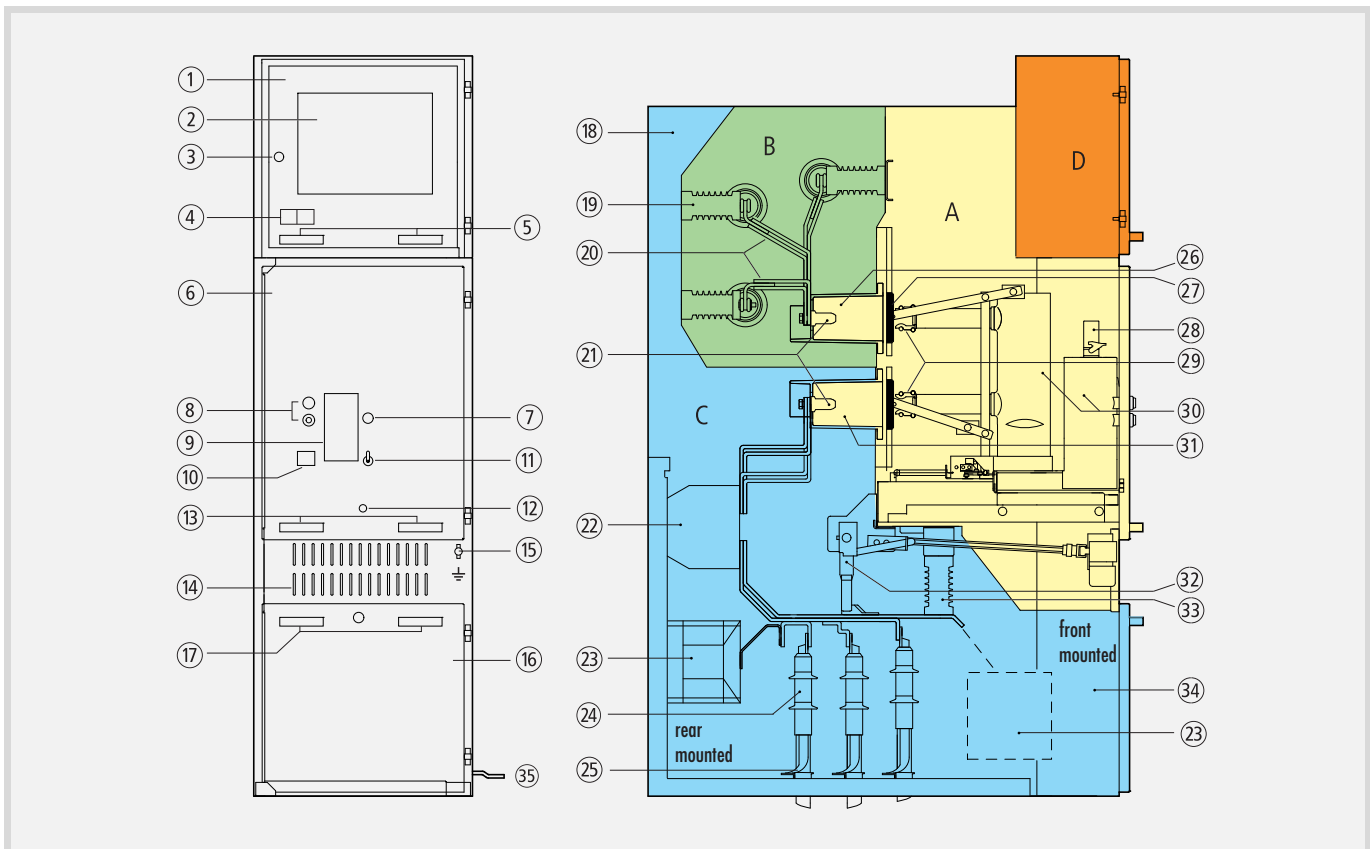

A - drawer unit compartment

B - busbar compartment

C - cable connection compartment

D - low voltage compartment

- | | |
|--|--|
| ① Low voltage compartment door (front cover) | ⑳ Main and outgoing busbars |
| ② Low voltage compartment door (application-specific) | ㉑ Panel fixed contacts |
| ③ Door closing | ㉒ Current transformers |
| ④ Capacitive voltage detection system (optional) | ㉓ Voltage transformers |
| ⑤ Low voltage compartment door handles | ㉔ Cable terminations |
| ⑥ Drawer unit compartment door | ㉕ Cable fixing irons |
| ⑦ Operation opening for manual winding up of spring accumulator | ㉖ Busbar / drawer unit compartment insulating bushings |
| ⑧ Manual operation of switch | ㉗ Automatic metal shutters |
| ⑨ Viewing window - switch indicators | ㉘ Switch low voltage connector |
| ⑩ Manual operation of switch | ㉙ Switch contact system |
| ⑪ Slide for the operation opening | ㉚ Switch drawer unit |
| ⑫ Operation opening for drawer unit | ㉛ Cable connection / drawer unit compartment insulating bushings |
| ⑬ Drawer unit compartment door handles | ㉜ Earthing switch with manual actuator
(optional motorised driving mechanism) |
| ⑭ Louvres | ㉝ Outgoing cable support insulator
(optional capacitive voltage detection system) |
| ⑮ Manual operation of earthing switch | ㉞ Wiring duct |
| ⑯ Cable connection compartment door | ㉟ Earthing busbar |
| ⑰ Cable connection compartment door handles | |
| ⑱ Cable connection compartment pressure relief channel | |
| ⑲ Busbar support insulator
(optional capacitive voltage detection system) | |

Medium-voltage switchgear up to 17.5 kV, air-insulated, metal-clad, withdrawable technique, Type AMC

Key to type references

Key to type references

Type reference key of panels¹⁾

AMC → (Air-insulated Metal Clad) panels can be equipped with a wide variety of standardised customer options. The panel types are differentiated in their widths, ratings and principal functions.

AMC. ①.-. ② ./ ③.-. ④ ./ ⑤.-. ⑥ .

Example : AMC6-12/1250-630/25-L

① Panel width:	6 = 650 mm 9 = 900 mm
② Rated voltage:	7 = 7.2 kV 12 = 12 kV 17 = 17.5 kV
③ Rated busbar current:	630 A 1250 A 2500 A ⁴⁾
④ Rated current of outgoing busbar:	200 A 630 A 1250 A 2500 A ⁴⁾
⑤ Rated short-time withstand current:	20 = 20 kA 25 = 25 kA 31 = 31.5 kA
⑥ Principal functions:	L = Circuit-breaker panel LG = Bus sectionaliser circuit-breaker panel K = Load break switch panel T = Load break switch panel with HRC fuse base M1 = Metering panel, sectionaliser panel M5 = Metering panel with outgoing cables M6 = Metering panel, busbar voltage measurement H = Busbar riser panel with cable connection HG = Bus sectionaliser riser panel E = Busbar earthing panel S = Contactor panel

Type reference key for AMC drawer units²⁾

The AMC drawer units differ depending on the type of equipment and its technical rated values.

N. ①. ② F-. ③ ./ ④ ./ ⑤.-. ⑥.-C

Example : NVL2F-12/25/1250-150C

① Type of equipment:	VL = Vacuum circuit-breaker VLT = Vacuum load-break switch VS = Vacuum contactor TB = Disconnecting link
② Type of insulating enclosure:	2, 3
③ Rated voltage:	7 = 7.2 kV 12 = 12 kV 17 = 17.5 kV
④ Rated short-circuit breaking current ³⁾ :	20 = 20 kA 25 = 25 kA 31 = 31.5 kA
⑤ Rated current:	200 A 630 A 1250 A 2500 A ⁴⁾
⑥ Distance between pole centres:	150 mm 210 mm

1) Range of individual panel types and their main components → pages 12 to 33.

2) Assignment of drawer units → pages 34 to 41.

3) For vacuum load-break switches and disconnecting links the rated short-time withstand current is stated.

4) For rated voltage 17.5 kV the rated current is 2000 A

Medium-voltage switchgear up to 17.5 kV, air-insulated, metal-clad, withdrawable technique, Type AMC

Operation/interlocking

Operation/interlocking

Operation at the panel

To ensure quick and reliable operation of the panel, the operating and display elements are positioned for clear viewing and for clear association. Capacitive voltage detection systems for the outgoing cables and/or main busbars can be equipped as options.

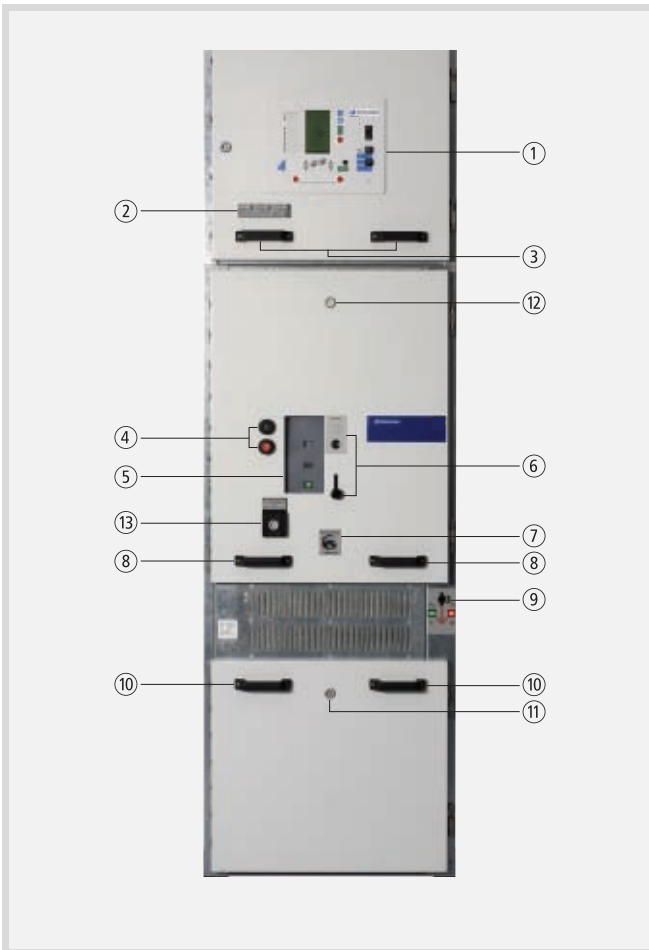

Circuit-breaker panel with operator interface

- ① Operating and display elements (panel controls) with integrated protection system
- ② Capacitive voltage detection system
- ③ Low voltage compartment door handles
- ④ Switch operation, mechanical ON - OFF
- ⑤ Switch status indication, mechanical ON - OFF, Operating spring charged - discharged
- ⑥ Operation opening for manual winding up of spring accumulator
- ⑦ Operation opening for drawer unit crank handle
- ⑧ Drawer unit compartment door handles
- ⑨ Driving mechanism – earthing switch with mechanical position indicator
- ⑩ Cable connection compartment door handles
- ⑪ Cable connection compartment door interlocking
- ⑫ Drawer unit compartment door interlocking
- ⑬ Twist handle for manual operation of the switch

Interlocking system

The interlocking of panel components according to VDE 0671 part 200 respectively IEC 62271-200 and optional additional interlocking features of type AMC panels, in connection with the metal-clad panel design, form a safe system and also assist the operator in performance of his operations. The following mechanical interlocking is provided:

- The drawer unit with the switch can be moved only when the switch and the earthing switch in the panel are switched off.
- The switch can only be switched when the drawer unit is either in the disconnected position or the connected position.
- The drawer unit can be moved only if the low-voltage plug for the auxiliary circuits and the control circuits is plugged in and interlocked.
- The low voltage plug for connecting the auxiliary circuit and the control circuits can only be unplugged from the switch when the drawer unit is in the disconnected position.
- The drawer unit can be moved from the disconnected position only when the interlock between drawer unit and panel is active.
- Once the drawer unit has moved away from the disconnected position, the interlocking between drawer unit and panel cannot be released.
- The switch at the drawer unit is not switchable whilst the drawer is moving to the end positions.
- The manual crank for moving the drawer unit can be inserted or removed only when the drawer unit is either in the disconnected position or the connected position.
- The earthing switch in the panel frame can be switched only when the drawer unit is in the disconnected position or has been removed completely out of the panel.
- Once the earthing switch is connected, the drawer unit cannot move from the disconnected position to the connected position.
- The manual crank for moving the drawer units can be inserted or removed only when the panel door is closed.

Optional interlockings:

- The drawer unit compartment door can be opened only when the drawer unit is in the disconnected position.
- The cable connection compartment door can be opened only if the earthing switch is connected.

Medium-voltage switchgear up to 17.5 kV, air-insulated, metal-clad, withdrawable technique, Type AMC

Technical data/standards

Technical data/standards

Technical data for AMC panels

		Rated voltage U_r [kV]			
		7.2	12	17.5	
Rated frequency f_r		Hz	50/60	50/60	50/60
Rated lightning impulse withstand voltage U_p		kV	60	75	95
Rated power-frequency withstand voltage U_d		kV	20	28	38
Rated normal current $I_{r,ss}$ for busbars	Optional	A	630	630	630
		A	1250	1250	1250
		A	2500	2500	2000
Rated normal current I_r for outgoing busbars	Optional ¹⁾	A	630	630	630
		A	1250	1250	1250
		A	2500	2500	2000
Rated short-time withstand current I_k with $t_k = 3$ s	Optional	kA	20	20	20
		kA	25	25	25
		kA	31.5	31.5	31.5
Rated peak withstand current I_p at $f_r = 50$ Hz		kA	50	50	50
		kA	62.5	62.5	62.5
		kA	80	80	80
Ambient temperature T		°C	-5 to +40		
Average measured over 24 h maximum		°C	+35		
Relative humidity					
Average measured over 24 h maximum		%	95		
Average measured over 1 month maximum		%	90		
Altitude maximum		m	1000		
Arc-fault qualification	up to		IAC AFL 31.5 kA 1 s		
Loss of service continuity	category		LSC2B		
Partition class			PM		
Degree of Protection of the external enclosure			IP4X		
Panel door colour (standard)			RAL 7035		

1) Rated normal current for outgoing busbars

Load-break switch panel	= 630 A
Load-break panel / metering panel with HRC fuse base	= 200 A; rated short-time withstand current I_k limited by HRC fuses
Vacuum contactor panel	= 200 A continuously rated load, detailed selection page 32; Rated short-time withstand current I_k limited by HRC fuses

Standards

AMC panels satisfy the listed VDE standards and IEC publications:

DIN VDE 0671 Part 200	IEC publication 62271-200
DIN VDE 0670 Part 1000	IEC publication 60694
	IEC publication 62271-100
	IEC publication 62271-102

Medium-voltage switchgear up to 17.5 kV, air-insulated, metal-clad, withdrawable technique, Type AMC

Delivery programme circuit-breaker panel

Delivery programme circuit-breaker panel

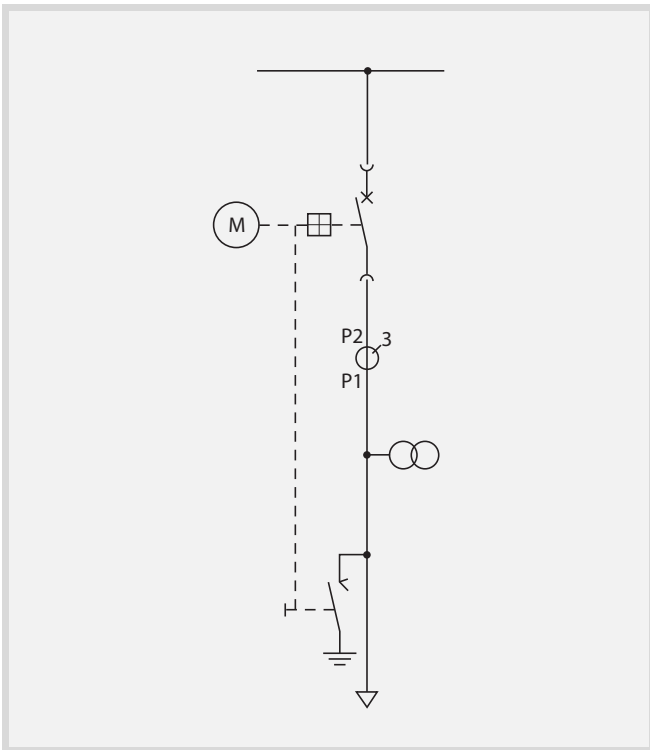

Configuration example for panel type ...-L
Other equipment options → page 13.

Technical data and dimensions²⁾:

		Rated voltage U_r [kV]		
		7.2	12	17.5
Rated normal current I_r for outgoing busbars	A	630	630	630
	A	1250	1250	1250
	A	2500	2500	2000
Panel height				
Standard incl. arc-deflecting shield	mm	2700	2700	2700
with pressure relief channel	mm	2900	2900	2900
Panel depth				
	mm	1400	1400	1400
Panel width for I_r				
≤ 1250 A	mm	650/ 900	650/ 900	650/ 900
> 1250 A up to 2500 A	mm	900	900	900

2) Additional technical data → pages 9 and 11.

Panel types ¹⁾	Rated voltage U_r [kV]		
	7.2	12	17.5
AMC6-12/630-630/20-L	•	•	
AMC6-12/1250-630/20-L	•	•	
AMC6-12/1250-1250/20-L	•	•	
AMC6-12/2500-630/20-L	•	•	
AMC6-12/2500-1250/20-L	•	•	
AMC6-12/630-630/25-L	•	•	
AMC6-12/1250-630/25-L	•	•	
AMC6-12/1250-1250/25-L	•	•	
AMC6-12/2500-630/25-L	•	•	
AMC6-12/2500-1250/25-L	•	•	
AMC6-12/630-630/31-L	•	•	
AMC6-12/1250-630/31-L	•	•	
AMC6-12/1250-1250/31-L	•	•	
AMC6-12/2500-630/31-L	•	•	
AMC6-12/2500-1250/31-L	•	•	
AMC9-12/630-630/20-L	•	•	
AMC9-12/1250-630/20-L	•	•	
AMC9-12/1250-1250/20-L	•	•	
AMC9-12/2500-630/20-L	•	•	
AMC9-12/2500-1250/20-L	•	•	
AMC9-12/2500-2500/20-L	•	•	
AMC9-12/630-630/25-L	•	•	
AMC9-12/1250-630/25-L	•	•	
AMC9-12/1250-1250/25-L	•	•	
AMC9-12/2500-630/25-L	•	•	
AMC9-12/2500-1250/25-L	•	•	
AMC9-12/2500-2500/25-L	•	•	
AMC9-12/630-630/31-L	•	•	
AMC9-12/1250-630/31-L	•	•	
AMC9-12/1250-1250/31-L	•	•	
AMC9-12/2500-630/31-L	•	•	
AMC9-12/2500-1250/31-L	•	•	
AMC9-12/2500-2500/31-L	•	•	
AMC6-17/630-630/20-L			•
AMC6-17/1250-630/20-L			•
AMC6-17/1250-1250/20-L			•
AMC6-17/2000-630/20-L			•
AMC6-17/2000-1250/20-L			•
AMC6-17/630-630/25-L			•
AMC6-17/1250-630/25-L			•
AMC6-17/1250-1250/25-L			•
AMC6-17/2000-630/25-L			•
AMC6-17/2000-1250/25-L			•
AMC6-17/630-630/31-L			•
AMC6-17/1250-630/31-L			•
AMC6-17/1250-1250/31-L			•
AMC6-17/2000-630/31-L			•
AMC6-17/2000-1250/31-L			•
AMC9-17/630-630/20-L			•
AMC9-17/1250-630/20-L			•
AMC9-17/1250-1250/20-L			•
AMC9-17/2000-630/20-L			•
AMC9-17/2000-1250/20-L			•
AMC9-17/2000-2000/20-L			•
AMC9-17/630-630/25-L			•
AMC9-17/1250-630/25-L			•
AMC9-17/1250-1250/25-L			•
AMC9-17/2000-630/25-L			•
AMC9-17/2000-1250/25-L			•
AMC9-17/2000-2000/25-L			•
AMC9-17/630-630/31-L			•
AMC9-17/1250-630/31-L			•
AMC9-17/1250-1250/31-L			•
AMC9-17/2000-630/31-L			•
AMC9-17/2000-1250/31-L			•
AMC9-17/2000-2000/31-L			•

1) Key to type references → page 9.

Medium-voltage switchgear up to 17.5 kV, air-insulated, metal-clad, withdrawable technique, Type AMC

Equipment for circuit-breaker panel

Equipment for circuit-breaker panel

Equipment options for AMC circuit-breaker panels

Low-voltage compartment¹⁾:

- height 600 mm (standard)
- height 800 mm
- door with padlock interlocking

Busbar compartment¹⁾:

- busbars 630 A
- busbars 1250 A
- busbars 2500 A
- capacitive voltage detection system at busbars

Cable connection compartment¹⁾:

- outgoing busbars 630 A
- outgoing busbars 1250 A
- outgoing busbars 2500 A (only at panel width 900 mm)
- support current transformer 1 core
- support current transformer 2 cores
- support current transformer 3 cores
- voltage transformer single phase, 1 winding, rear mounted
- voltage transformer single phase, 2 windings, rear mounted
- voltage transformer single phase, 3 windings, rear mounted
- voltage measurement before current measurement, rear mounted
- voltage measurement after current measurement, rear mounted
- fixed compensation 3ph up to 133 kVAR, 7.2 kV; up to 100 kVAR, 12 kV³⁾
- earthing switch⁵⁾, manual operation
- earthing switch⁵⁾, manual operation with electro-mechanical interlocking
- earthing switch with motorised drive⁵⁾
- voltage transformer single phase, 1 winding, front mounted
- voltage transformer single phase, 2 windings, front mounted
- voltage transformer single phase, 1 winding, with primary fuse up to 10 kV, front mounted
- voltage transformer single phase, 2 windings, with primary fuse up to 10 kV, front mounted
- surge arrester up to 10 kV at outgoing, front mounted⁴⁾
- cable connection 1 system per phase
- cable connection 2 systems per phase
- cable connection 3 systems per phase
- cable connection 4 systems per phase (only at panel width 900 mm)
- cable connection 5 systems per phase (only at panel width 900 mm)
- cable connection 6 systems per phase (only at panel width 900 mm)
- cable lug termination M12
- cable lug termination M16
- cable clamp size 1 (→ page 7)
- cable clamp size 2 (→ page 7)
- ball terminal bolt 25 mm, L1-L3 and panel fixing point for earthing
- door with padlock interlocking
- door interlocking by earthing switch
- door interlocking electro-mechanical.
- capacitive voltage detection system at outgoing cable

Panel extension above^{1) 6)}:

- busbar voltage transformer single phase up to 10 kV, 1 winding; up to 25 kA (only at panel width 650 mm)
- busbar voltage transformer single phase up to 10 kV, 2 windings; up to 25 kA (only at panel width 650 mm)
- busbar earthing switch⁵⁾ up to 10 kV, 25 kA, manual operation; (only at panel width 650 mm)
- busbar earthing switch⁵⁾ up to 10 kV, 25 kA, manual operation with electro-mechanical interlocking; (only at panel width 650 mm)
- surge arrester at busbars up to 10 kV, 25 kA (only at panel width 650 mm)
- arc absorber assembly (standard equipment for AMC9)

Type: AMC...-...../.....-...../.....-L

Example : AMC6-12/1250-630/25-L

Drawer unit compartment¹⁾:

- vacuum circuit-breaker 630 A²⁾
- vacuum circuit-breaker 630 A with motorised drive²⁾
- vacuum circuit-breaker 1250 A²⁾
- vacuum circuit-breaker 1250 A with motorised drive²⁾
- vacuum circuit-breaker 2500 A (only at panel width 900 mm)²⁾
- vacuum circuit-breaker 2500 A with motorised drive (only at panel width 900 mm)²⁾
- panel connection bolt M16 for earthing drawer unit / manual
- door with manual switch operation
- door with manual switch operation, padlock interlocking
- door without operation opening
- door with padlock interlocking
- door interlocking with drawer unit position, mechanical
- door interlocking electro-mechanical
- drawer unit with mechanical interlocking to the earthing switch
- drawer unit with mechanical interlocking to the earthing switch and motorised drive for drawer movement
- drawer unit with mechanical interlocking to the earthing switch and electro-mechanical interlocking to the drawer movement

Panel covers above¹⁾:

- arc-deflecting shield 500 mm (standard)
- pressure relief channel in panel partition (panel height 2900 mm) without channel from the switchgear room

Standard protection and control system:

- panel control system with integral directional time overcurrent protection
- panel control system with integral cable differential protection
- panel control system with integral transformer differential protection
- standard control circuit with time overcurrent protection
- standard control circuit with directional time overcurrent protection
- customer-specific protection and control systems

Auxiliary voltages for motorised drives, electro-mechanical interlocking and controls:

- 24 V DC
- 48 V DC
- 60 V DC
- 110 V DC
- 220 V DC
- 110 V AC
- 230 V AC

Customer-specific current and voltage transformers:

Ratings:

-
-
-
- 1) Mounting positions for equipment → page 8
Only one equipment variant can be assembled at each mounting position.
 - 2) Equipment of switch → pages 34 and 35
 - 3) Only one cable connection per phase possible
 - 4) Necessary for MV motor and generator applications
 - 5) Equipment of earthing switch → pages 42 and 43
 - 6) Not possible when panel cover above option pressure relief channel is used

Medium-voltage switchgear up to 17.5 kV, air-insulated, metal-clad, withdrawable technique, Type AMC

Delivery programme load-break switch panel

Delivery programme load-break switch panel

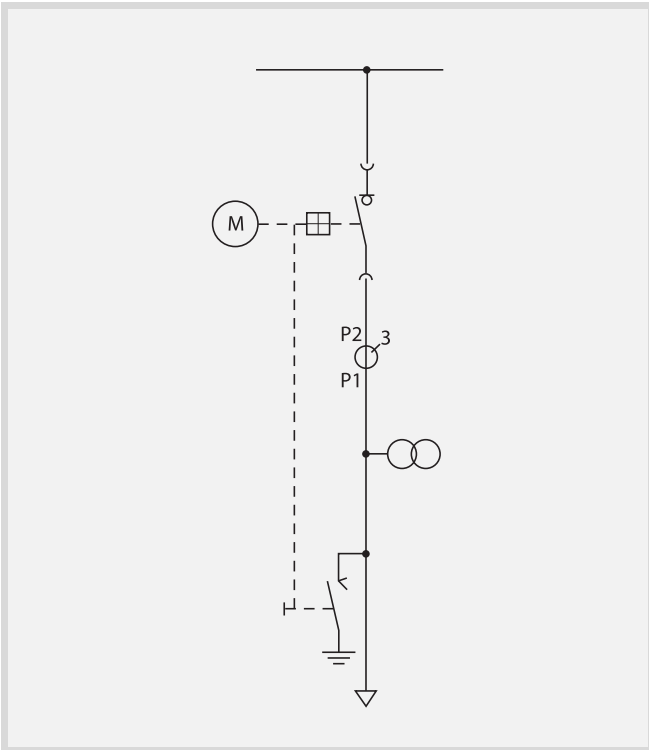

Configuration example for panel type ...-K
Other equipment options → page 15.

Panel types ¹⁾	Rated voltage U_r [kV]		
	7.2	12	17.5
AMC6-12/630-630/20-K	•	•	
AMC6-12/1250-630/20-K	•	•	
AMC6-12/2500-630/20-K	•	•	
AMC6-12/630-630/25-K	•	•	
AMC6-12/1250-630/25-K	•	•	
AMC6-12/2500-630/25-K	•	•	
AMC6-17/630-630/20-K			•
AMC6-17/1250-630/20-K			•
AMC6-17/2000-630/20-K			•
AMC6-17/630-630/25-K			•
AMC6-17/1250-630/25-K			•
AMC6-17/2000-630/25-K			•

1) Key to type references → page 9.

Technical data and dimensions²⁾:

		Rated voltage U_r [kV]		
		7.2	12	17.5
Rated normal current I_r for outgoing busbars	A	630	630	630
Panel height				
Standard incl. arc-deflecting shield	mm	2700	2700	2700
with pressure relief channel	mm	2900	2900	2900
Panel depth				
	mm	1400	1400	1400
Panel width for I_r				
630 A	mm	650	650	650

2) Additional technical data → pages 9 and 11.

Medium-voltage switchgear up to 17.5 kV, air-insulated, metal-clad, withdrawable technique, Type AMC

Equipment for load-break switch panel

Equipment for load-break switch panel

Equipment options for AMC load-break switch panels

Low-voltage compartment¹⁾:

- height 600 mm (standard)
- height 800 mm
- door with padlock interlocking

Busbar compartment¹⁾:

- busbars 630 A
- busbars 1250 A
- busbars 2500 A
- capacitive voltage detection system at busbars

Cable connection compartment¹⁾:

- support current transformer 1 core
- support current transformer 2 cores
- support current transformer 3 cores
- voltage transformer single phase, 1 winding, rear mounted
- voltage transformer single phase, 2 windings, rear mounted
- voltage transformer single phase, 3 windings, rear mounted
- voltage measurement before current measurement, rear mounted
- voltage measurement after current measurement, rear mounted
- fixed compensation 3ph up to 133 kVAR, 7.2 kV; up to 100 kVAR, 12 kV³⁾
- earthing switch⁴⁾, manual operation
- earthing switch⁴⁾, manual operation with electro-mechanical interlocking
- earthing switch with motorised drive⁴⁾
- voltage transformer single phase, 1 winding, front mounted
- voltage transformer single phase, 2 windings, front mounted
- voltage transformer single phase, 1 winding, with primary fuse up to 10 kV, front mounted
- voltage transformer single phase, 2 windings, with primary fuse up to 10 kV, front mounted
- surge arrester up to 10 kV at outgoing, front mounted
- cable connection 1 system per phase
- cable connection 2 systems per phase
- cable connection 3 systems per phase
- cable lug termination M12
- cable lug termination M16
- cable clamp size 1 (→ page 7)
- cable clamp size 2 (→ page 7)
- ball terminal bolt 25 mm, L1-L3 and panel fixing point for earthing
- door with padlock interlocking
- door interlocking by earthing switch
- door interlocking electro-mechanical.
- capacitive voltage detection system at outgoing cable

Panel extension above^{1) 5)}:

- busbar voltage transformer single phase up to 10 kV, 1 winding; up to 25 kA
- busbar voltage transformer single phase up to 10 kV, 2 windings; up to 25 kA
- busbar earthing switch⁴⁾ up to 10 kV, 25 kA, manual operation
- busbar earthing switch⁴⁾ up to 10 kV, 25 kA, manual operation with electro-mechanical interlocking
- surge arrester at busbars up to 10 kV, 25 kA
- arc absorber assembly

Type: AMC6-...../.....-630/.....-K

Example : AMC6-12/1250-630/20-K

Drawer unit compartment¹⁾:

- vacuum circuit-breaker 630 A²⁾
- Panel connection bolt M16 for earthing drawer unit / manual
- door with manual switch operation
- door with manual switch operation, padlock interlocking
- door without operation opening
- door with padlock interlocking
- door interlocking with drawer unit position, mechanical
- door interlocking electro-mechanical
- drawer unit with mechanical interlocking to the earthing switch
- drawer unit with mechanical interlocking to the earthing switch and motorised drive for drawer movement
- drawer unit with mechanical interlocking to the earthing switch and electro-mechanical interlocking to the drawer movement

Panel covers above¹⁾:

- arc-deflecting shield 500 mm (standard)
- pressure relief channel in panel partition (panel height 2900 mm) without channel from the switchgear room

Standard protection and control system:

- panel control system
- standard control circuit
- customer-specific control circuit

Auxiliary voltages for motorised drives, electro-mechanical interlocking and controls:

- 24 V DC
- 48 V DC
- 60 V DC
- 110 V DC
- 220 V DC
- 110 V AC
- 230 V AC

Customer-specific current and voltage transformers:

Ratings:

.....

.....

.....

- 1) Mounting positions for equipment → page 8
Only one equipment variant can be assembled at each mounting position.
- 2) Equipment of switch → pages 36 and 37
- 3) Only one cable connection per phase possible
- 4) Equipment of earthing switch → pages 42 and 43
- 5) Not possible when panel cover above option pressure relief channel is used

Medium-voltage switchgear up to 17.5 kV, air-insulated, metal-clad, withdrawable technique, Type AMC

Delivery programme load-break switch panel with HRC fuse base

Delivery programme load-break switch panel with HRC fuse base

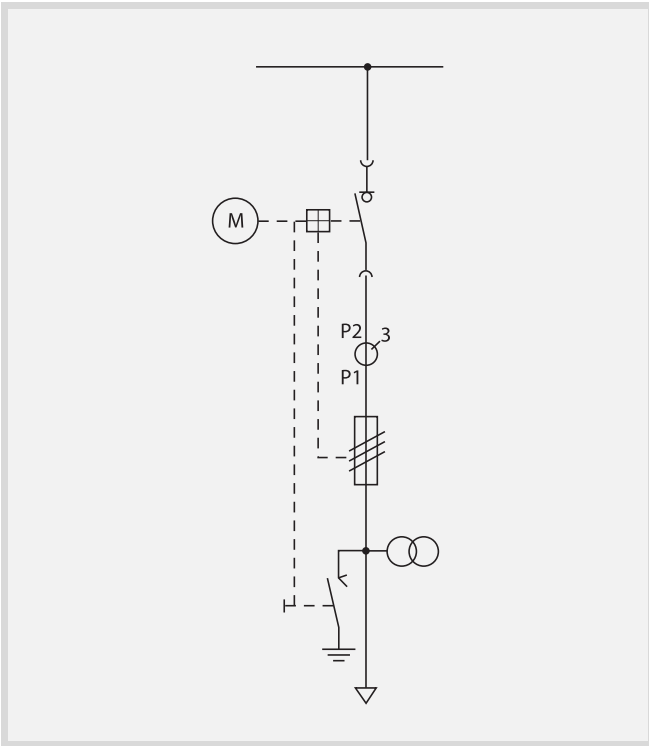

Configuration example for panel type ...-T
Other equipment options → page 17.

Panel types ¹⁾	Rated voltage U_r [kV]	
	7.2	12
AMC6-12/630-200/20-T	•	•
AMC6-12/1250-200/20-T	•	•
AMC6-12/2500-200/20-T	•	•
AMC6-12/630-200/25-T	•	•
AMC6-12/1250-200/25-T	•	•
AMC6-12/2500-200/25-T	•	•
AMC6-12/630-200/31-T	•	•
AMC6-12/1250-200/31-T	•	•
AMC6-12/2500-200/31-T	•	•

1) Key to type references → page 9.

The rated short-time withstand current I_k at the outgoing busbars is limited by the HRC fuses.

The three-phase tripping of the load-break switch (optional) is performed electrically by the auxiliary contacts of the fuse base and the load-break switch trip element.

At HRC fuse base high voltage fuses according to DIN 43625 and IEC 60282-1, dimension $e = 292$ mm, $d =$ up to 85 mm can be implemented.

Technical data and dimensions²⁾:

		Rated voltage U_r [kV]	
		7.2	12
Rated normal current I_r for outgoing busbars	A	200	200
Panel height			
Standard incl. arc-deflecting shield	mm	2700	2700
with pressure relief channel	mm	2900	2900
Panel depth			
	mm	1400	1400
Panel width for I_r			
200 A	mm	650	650

2) Additional technical data → pages 9 and 11.

Medium-voltage switchgear up to 17.5 kV, air-insulated, metal-clad, withdrawable technique, Type AMC

Equipment for load-break switch panel with HRC fuse base

Equipment for load-break switch panel with HRC fuse base

Equipment options for AMC - load-break switch panels with HRC fuse base

Type: AMC6-12/.....-200/.....-T

Example: AMC6-12/1250-200/25-T

Low-voltage compartment¹⁾:

- height 600 mm (standard)
- height 800 mm
- door with padlock interlocking

Busbar compartment¹⁾:

- busbars 630 A
- busbars 1250 A
- busbars 2500 A
- capacitive voltage detection system at busbars

Cable connection compartment¹⁾:

- support current transformer 1 core
- support current transformer 2 cores
- support current transformer 3 cores
- voltage transformer single phase, 1 winding, rear mounted
- voltage transformer single phase, 2 windings, rear mounted
- voltage transformer single phase, 3 windings, rear mounted
- voltage measurement before current measurement
- voltage measurement after current measurement
- HRC fuse base 3ph with auxiliary contacts 1NO + 1NC for tripping or indication for HRC fuses e = 292 mm, d = up to 85 mm
- earthing switch³⁾, manual operation
- earthing switch³⁾, manual operation with electro-mechanical interlocking
- earthing switch with motorised drive³⁾
- surge arrester up to 10 kV at outgoing, front mounted
- cable connection 1 system per phase
- cable lug termination M12
- cable clamp size 1 (→ page 7)
- door with padlock interlocking
- door interlocking by earthing switch
- door interlocking electro-mechanical.
- capacitive voltage detection system at outgoing cable

Panel extension above^{1) 4)}:

- busbar voltage transformer single phase up to 10 kV, 1 winding; up to 25 kA
- busbar voltage transformer single phase up to 10 kV, 2 windings; up to 25 kA
- busbar earthing switch³⁾ up to 10 kV, 25 kA, manual operation
- busbar earthing switch³⁾ up to 10 kV, 25 kA, manual operation with electro-mechanical interlocking
- surge arrester at busbars up to 10 kV, 25 kA
- arc absorber assembly

Drawer unit compartment¹⁾:

- vacuum circuit-breaker 630 A²⁾
- panel connection bolt M16 for earthing drawer unit / manual
- door with manual switch operation
- door with manual switch operation, padlock interlocking
- door without operation opening
- door with padlock interlocking
- door interlocking with drawer unit position, mechanical
- door interlocking electro-mechanical
- drawer unit with mechanical interlocking to the earthing switch
- drawer unit with mechanical interlocking to the earthing switch and motorised drive for drawer movement
- drawer unit with mechanical interlocking to the earthing switch and electro-mechanical interlocking to the drawer movement

Panel covers above¹⁾:

- arc-deflecting shield 500 mm (standard)
- pressure relief channel in panel partition (panel height 2900 mm) without channel from the switchgear room

Standard protection and control system:

- panel control system
- standard control circuit
- customer-specific control circuit

Auxiliary voltages for motorised drives, electro-mechanical interlocking and controls:

- 24 V DC
- 48 V DC
- 60 V DC
- 110 V DC
- 220 V DC
- 110 V AC
- 230 V AC

Customer-specific current and voltage transformers:

Ratings:

.....

.....

.....

- 1) Mounting positions for equipment → page 8
Only one equipment variant can be assembled at each mounting position.
- 2) Equipment of switch → pages 36 and 37
- 3) Equipment of earthing switch → pages 42 and 43
- 4) Not possible when panel cover above option pressure relief channel is used

Medium-voltage switchgear up to 17.5 kV, air-insulated, metal-clad, withdrawable technique, Type AMC
 Delivery programme bus sectionaliser circuit-breaker panel

Delivery programme bus sectionaliser circuit-breaker panel

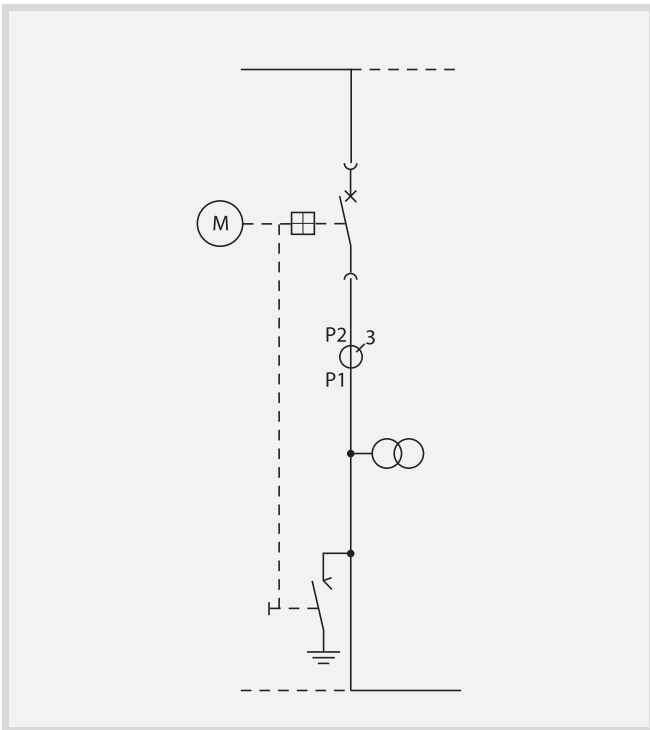

Configuration example for panel type ...-LG
 Other equipment options → page 19.

Technical data and dimensions²⁾:

		Rated voltage U_r [kV]		
		7.2	12	17.5
Rated current I_r for main busbars and section busbars	A	630	630	630
	A	1250	1250	1250
	A	2500	2500	2000
Panel height				
Standard incl. arc-deflecting shield	mm	2700	2700	2700
with pressure relief channel	mm	2900	2900	2900
Panel depth				
	mm	1400	1400	1400
Panel width for I_r				
≤ 1250 A	mm	650/ 900	650/ 900	650/ 900
> 1250 A up to 2500 A	mm	900	900	900

2) Additional technical data → pages 9 and 11.

Panel types ¹⁾	Rated voltage U_r [kV]		
	7.2	12	17.5
AMC6-12/630-630/20-LG	•	•	
AMC6-12/1250-630/20-LG	•	•	
AMC6-12/1250-1250/20-LG	•	•	
AMC6-12/2500-630/20-LG	•	•	
AMC6-12/2500-1250/20-LG	•	•	
AMC6-12/630-630/25-LG	•	•	
AMC6-12/1250-630/25-LG	•	•	
AMC6-12/1250-1250/25-LG	•	•	
AMC6-12/2500-630/25-LG	•	•	
AMC6-12/2500-1250/25-LG	•	•	
AMC6-12/630-630/31-LG	•	•	
AMC6-12/1250-630/31-LG	•	•	
AMC6-12/1250-1250/31-LG	•	•	
AMC6-12/2500-630/31-LG	•	•	
AMC6-12/2500-1250/31-LG	•	•	
AMC9-12/630-630/20-LG	•	•	
AMC9-12/1250-630/20-LG	•	•	
AMC9-12/1250-1250/20-LG	•	•	
AMC9-12/2500-630/20-LG	•	•	
AMC9-12/2500-1250/20-LG	•	•	
AMC9-12/2500-2500/20-LG	•	•	
AMC9-12/630-630/25-LG	•	•	
AMC9-12/1250-630/25-LG	•	•	
AMC9-12/1250-1250/25-LG	•	•	
AMC9-12/2500-630/25-LG	•	•	
AMC9-12/2500-1250/25-LG	•	•	
AMC9-12/2500-2500/25-LG	•	•	
AMC9-12/630-630/31-LG	•	•	
AMC9-12/1250-630/31-LG	•	•	
AMC9-12/1250-1250/31-LG	•	•	
AMC9-12/2500-630/31-LG	•	•	
AMC9-12/2500-1250/31-LG	•	•	
AMC9-12/2500-2500/31-LG	•	•	
AMC6-17/630-630/20-LG			•
AMC6-17/1250-630/20-LG			•
AMC6-17/1250-1250/20-LG			•
AMC6-17/2000-630/20-LG			•
AMC6-17/2000-1250/20-LG			•
AMC6-17/630-630/25-LG			•
AMC6-17/1250-630/25-LG			•
AMC6-17/1250-1250/25-LG			•
AMC6-17/2000-630/25-LG			•
AMC6-17/2000-1250/25-LG			•
AMC6-17/630-630/31-LG			•
AMC6-17/1250-630/31-LG			•
AMC6-17/1250-1250/31-LG			•
AMC6-17/2000-630/31-LG			•
AMC6-17/2000-1250/31-LG			•
AMC9-17/630-630/20-LG			•
AMC9-17/1250-630/20-LG			•
AMC9-17/1250-1250/20-LG			•
AMC9-17/2000-630/20-LG			•
AMC9-17/2000-1250/20-LG			•
AMC9-17/2000-2000/20-LG			•
AMC9-17/630-630/25-LG			•
AMC9-17/1250-630/25-LG			•
AMC9-17/1250-1250/25-LG			•
AMC9-17/2000-630/25-LG			•
AMC9-17/2000-1250/25-LG			•
AMC9-17/2000-2000/25-LG			•
AMC9-17/630-630/31-LG			•
AMC9-17/1250-630/31-LG			•
AMC9-17/1250-1250/31-LG			•
AMC9-17/2000-630/31-LG			•
AMC9-17/2000-1250/31-LG			•
AMC9-17/2000-2000/31-LG			•

1) Key to type references → page 9.

Medium-voltage switchgear up to 17.5 kV, air-insulated, metal-clad, withdrawable technique, Type AMC

Equipment for bus sectionaliser circuit-breaker panel

Equipment for bus sectionaliser circuit-breaker panel

Equipment options for AMC - bus sectionaliser circuit-breaker panels

Type: AMC...-...../.....-...../.....-LG

Example: AMC9-12/2500-2500/31-LG

Low-voltage compartment¹⁾:

- height 600 mm (standard)
- height 800 mm
- door with padlock interlocking

Busbar compartment¹⁾:

- busbars 630 A
- busbars 1250 A
- busbars 2500 A
- capacitive voltage detection system at busbars

Cable connection compartment¹⁾:

- section busbars 630 A
- section busbars 1250 A
- section busbars 2500 A (only at panel width 900 mm)
- support current transformer 1 core
- support current transformer 2 cores
- support current transformer 3 cores
- voltage transformer single phase, 1 winding, rear mounted
- voltage transformer single phase, 2 windings, rear mounted
- voltage transformer single phase, 3 windings, rear mounted
- voltage measurement before current measurement, rear mounted
- voltage measurement after current measurement, rear mounted
- earthing switch³⁾, manual operation
- earthing switch³⁾, manual operation with electro-mechanical interlocking
- earthing switch with motorised drive³⁾
- voltage transformer single phase, 1 winding, front mounted
- voltage transformer single phase, 2 windings, front mounted
- voltage transformer single phase, 1 winding, with primary fuse up to 10 kV, front mounted
- voltage transformer single phase, 2 windings, with primary fuse up to 10 kV, front mounted
- surge arrester up to 10 kV at section busbar, front mounted
- ball terminal bolt 25 mm, L1-L3 and panel fixing point for earthing
- door with padlock interlocking
- door interlocking by earthing switch
- door interlocking electro-mechanical.
- capacitive voltage detection system at outgoing cable

Panel extension above^{1) 4)}:

- busbar voltage transformer single phase up to 10 kV, 1 winding; up to 25 kA (only at panel width 650 mm)
- busbar voltage transformer single phase up to 10 kV, 2 windings; up to 25 kA (only at panel width 650 mm)
- busbar earthing switch³⁾ up to 10 kV, 25 kA, manual operation; (only at panel width 650 mm)
- busbar earthing switch³⁾ up to 10 kV, 25 kA, manual operation with electro-mechanical interlocking; (only at panel width 650 mm)
- surge arrester at busbars up to 10 kV, 25 kA (only at panel width 650 mm)
- arc absorber assembly (standard equipment for AMC9)

Drawer unit compartment¹⁾:

- vacuum circuit-breaker 630 A²⁾
- vacuum circuit-breaker 630 A with motorised drive²⁾
- vacuum circuit-breaker 1250 A²⁾
- vacuum circuit-breaker 1250 A with motorised drive²⁾
- vacuum circuit-breaker 2500 A (only at panel width 900 mm)²⁾
- vacuum circuit-breaker 2500 A with motorised drive (only at panel width 900 mm)²⁾
- panel connection bolt M16 for earthing drawer unit / manual
- door with manual switch operation
- door with manual switch operation, padlock interlocking
- door without operation opening
- door with padlock interlocking
- door interlocking with drawer unit position, mechanical
- door interlocking electro-mechanical
- drawer unit with mechanical interlocking to the earthing switch
- drawer unit with mechanical interlocking to the earthing switch and motorised drive for drawer movement
- drawer unit with mechanical interlocking to the earthing switch and electro-mechanical interlocking to the drawer movement

Panel covers above¹⁾:

- arc-deflecting shield 500 mm (standard)
- pressure relief channel in panel partition (panel height 2900 mm) without channel from the switchgear room

Standard protection and control system:

- panel control system with integral directional time overcurrent protection
- standard control circuit with time overcurrent protection
- standard control circuit with directional time overcurrent protection
- customer-specific protection and control systems

Auxiliary voltages for motorised drives, electro-mechanical interlocking and controls:

- 24 V DC
- 48 V DC
- 60 V DC
- 110 V DC
- 220 V DC
- 110 V AC
- 230 V AC

Customer-specific current and voltage transformers:

Ratings:

-
-
-
- 1) Mounting positions for equipment → page 8
Only one equipment variant can be assembled at each mounting position.
 - 2) Equipment of switch → pages 34 and 35
 - 3) Equipment of earthing switch → pages 42 and 43
 - 4) Not possible when panel cover above option pressure relief channel is used

Medium-voltage switchgear up to 17.5 kV, air-insulated, metal-clad, withdrawable technique, Type AMC

Delivery programme metering panel M1; sectionaliser panel

Delivery programme metering panel M1; sectionaliser panel

For the metering panel M1 - metering bus sectionaliser panel - there are three versions available:

1. Metering panel M1 - metering transformer configuration in the cable connection compartment, drawer unit compartment not used
2. Metering panel M1 - metering transformer configuration in the cable connection compartment, drawer unit compartment with disconnecting link
3. Metering panel M1 - metering transformer configuration fixed mounted in the drawer unit compartment

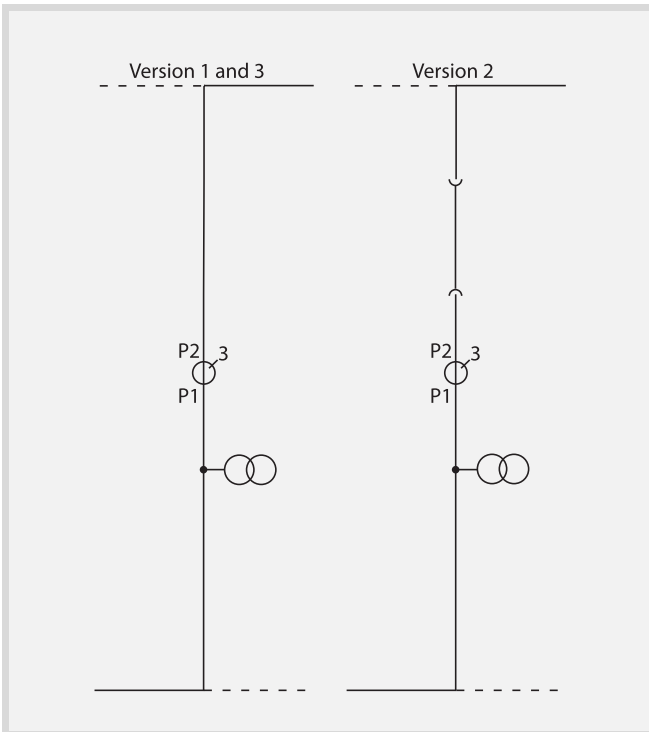

Configuration example for panel type ...-M1
Other equipment options → page 21.

Technical data and dimensions²⁾:

		Rated voltage U_r [kV]		
		7.2	12	17.5
Rated current I_r for main busbars and section busbars	A	630	630	630
	A	1250	1250	1250
	A	2500	2500	2000
Panel height				
Standard incl. arc-deflecting shield	mm	2700	2700	2700
with pressure relief channel	mm	2900	2900	2900
Panel depth				
	mm	1400	1400	1400
Panel width for I_r				
≤ 1250 A	mm	650/ 900	650/ 900	650/ 900
> 1250 A up to 2500 A	mm	900	900	900

2) Additional technical data → pages 9 and 11.

Panel types ¹⁾	Rated voltage U_r [kV]		
	7.2	12	17.5
AMC6-12/630-630/20-M1	•	•	
AMC6-12/630-630/25-M1	•	•	
AMC6-12/630-630/31-M1	•	•	
AMC6-12/1250-1250/20-M1	•	•	
AMC6-12/1250-1250/25-M1	•	•	
AMC6-12/1250-1250/31-M1	•	•	
AMC9-12/630-630/20-M1	•	•	
AMC9-12/630-630/25-M1	•	•	
AMC9-12/630-630/31-M1	•	•	
AMC9-12/1250-1250/20-M1	•	•	
AMC9-12/1250-1250/25-M1	•	•	
AMC9-12/1250-1250/31-M1	•	•	
AMC9-12/2500-2500/20-M1	•	•	
AMC9-12/2500-2500/25-M1	•	•	
AMC9-12/2500-2500/31-M1	•	•	
AMC6-17/630-630/20-M1			•
AMC6-17/630-630/25-M1			•
AMC6-17/630-630/31-M1			•
AMC6-17/1250-1250/20-M1			•
AMC6-17/1250-1250/25-M1			•
AMC6-17/1250-1250/31-M1			•
AMC9-17/630-630/20-M1			•
AMC9-17/630-630/25-M1			•
AMC9-17/630-630/31-M1			•
AMC9-17/1250-1250/20-M1			•
AMC9-17/1250-1250/25-M1			•
AMC9-17/1250-1250/31-M1			•
AMC9-17/2000-2000/20-M1			•
AMC9-17/2000-2000/25-M1			•
AMC9-17/2000-2000/31-M1			•

1) Key to type references → page 9.

Medium-voltage switchgear up to 17.5 kV, air-insulated, metal-clad, withdrawable technique, Type AMC

Equipment for metering panel M1; sectionaliser panel

Equipment for metering panel M1; sectionaliser panel

Equipment options for AMC - metering panels M1

Type: AMC...-...../.....-...../.....-M1

Example: AMC6-12/1250-1250/25-M1

For the metering panel M1 - metering bus sectionaliser panel - there are three versions available:

- 1. Metering panel M1 - metering transformer configuration in the cable connection compartment, drawer unit compartment not used
- 2. Metering panel M1 - metering transformer configuration in the cable connection compartment, drawer unit compartment with disconnecting link
- 3. Metering panel M1 - metering transformer configuration fixed mounted in the drawer unit compartment

Low-voltage compartment¹⁾:

- height 600 mm (standard)
- height 800 mm
- door with padlock interlocking

Busbar compartment¹⁾:

- busbars 630 A
- busbars 1250 A
- busbars 2500 A
- capacitive voltage detection system at busbars

Bus sectionaliser compartment¹⁾:

- support current transformer 1 core
- support current transformer 2 cores
- support current transformer 3 cores
- voltage transformer single phase, 1 winding, rear mounted
- voltage transformer single phase, 2 windings, rear mounted
- voltage transformer single phase, 3 windings, rear mounted
- voltage measurement before current measurement, rear mounted
- voltage measurement after current measurement, rear mounted
- voltage transformer single phase, 1 winding, front mounted
- voltage transformer single phase, 2 windings, front mounted
- voltage transformer single phase, 1 winding, with primary fuse up to 10 kV, front mounted
- voltage transformer single phase, 2 windings, with primary fuse up to 10 kV, front mounted
- surge arrester up to 10 kV at section busbar, front mounted
- ball terminal bolt 25 mm, L1-L3 and panel fixing point for earthing
- door with padlock interlocking
- capacitive voltage detection system at section busbars

Panel extension above^{1) 4)}:

- busbar voltage transformer single phase up to 10 kV, 1 winding; up to 25 kA (only at panel width 650 mm)
- busbar voltage transformer single phase up to 10 kV, 2 windings; up to 25 kA (only at panel width 650 mm)
- busbar earthing switch³⁾ up to 10 kV, 25 kA, manual operation; (only at panel width 650 mm)
- busbar earthing switch³⁾ up to 10 kV, 25 kA, manual operation with electro-mechanical interlocking; (only at panel width 650 mm)
- surge arrester at busbars up to 10 kV, 25 kA (only at panel width 650 mm)
- arc absorber assembly (standard equipment for AMC9)

Equipment compartment¹⁾:

- disconnecting link²⁾ 630 A, with electro-mechanical interlocking to drawer movement; (only for version 2)
- disconnecting link²⁾ 1250 A, with electro-mechanical interlocking to drawer movement; (only for version 2)
- disconnecting link²⁾ 2500 A, with electro-mechanical interlocking to drawer movement; (only for version 2) (only at panel width 900 mm)
- support current transformer 1 core; (only for version 3)
- support current transformer 2 cores; (only for version 3)
- voltage transformer single phase, 1 winding; (only for version 3)
- voltage transformer single phase, 2 windings; (only for version 3)
- voltage measurement before current measurement; (only for version 3)
- voltage measurement after current measurement; (only for version 3)
- panel connection bolt M16 for earthing drawer unit / manual; (only for version 2)
- door without operation opening (only for version 2)
- door with padlock interlocking
- door interlocking with drawer unit position, mechanical; (only for version 2)
- door interlocking electro-mechanical

Panel covers above¹⁾:

- arc-deflecting shield 500 mm (standard)
- pressure relief channel in panel partition (panel height 2900 mm) without channel from the switchgear room

Auxiliary voltages for electro-mechanical interlocking and controls (only for version 2):

- 24 V DC
- 48 V DC
- 60 V DC
- 110 V DC
- 220 V DC
- 110 V AC
- 230 V AC

Control systems:

- standard control circuit
- customer-specific control circuit

Customer-specific current and voltage transformers:

Ratings:

-
-
-
- 1) Mounting positions for equipment → page 8
Only one equipment variant can be assembled at each mounting position.
 - 2) Equipment of disconnecting link → pages 38 and 39
 - 3) Equipment of earthing switch → pages 42 and 43
 - 4) Not possible when panel cover above option pressure relief channel is used

Medium-voltage switchgear up to 17.5 kV, air-insulated, metal-clad, withdrawable technique, Type AMC

Delivery programme metering panel M5; with outgoing cables

Delivery programme metering panel M5; with outgoing cables

For the metering panel M5 with outgoing cables there are three versions available:

1. Metering panel M5 - metering transformer configuration in the cable connection compartment, drawer unit compartment not used
2. Metering panel M5 - metering transformer configuration in the cable connection compartment, drawer unit compartment with disconnecting link
3. Metering panel M5 - metering transformer configuration fixed mounted in the drawer unit compartment

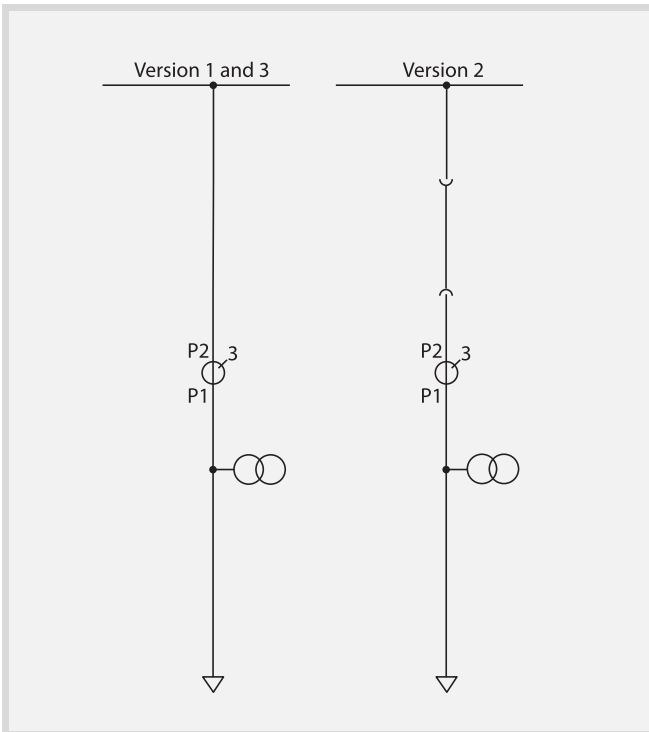

Configuration example for panel type ...-M5

Other equipment options → page 23.

Technical data and dimensions²⁾:

		Rated voltage U_r [kV]		
		7.2	12	17.5
Rated current I_r for outgoing busbars	A	630	630	630
	A	1250	1250	1250
	A	2500	2500	2000
Panel height				
Standard incl. arc-deflecting shield	mm	2700	2700	2700
with pressure relief channel	mm	2900	2900	2900
Panel depth				
	mm	1400	1400	1400
Panel width for I_r				
≤ 1250 A	mm	650/ 900	650/ 900	650/ 900
> 1250 A up to 2500 A	mm	900	900	900

2) Additional technical data → pages 9 and 11.

Panel types ¹⁾	Rated voltage U_r [kV]		
	7.2	12	17.5
AMC6-12/630-630/20-M5	•	•	
AMC6-12/1250-630/20-M5	•	•	
AMC6-12/1250-1250/20-M5	•	•	
AMC6-12/2500-630/20-M5	•	•	
AMC6-12/2500-1250/20-M5	•	•	
AMC6-12/630-630/25-M5	•	•	
AMC6-12/1250-630/25-M5	•	•	
AMC6-12/1250-1250/25-M5	•	•	
AMC6-12/2500-630/25-M5	•	•	
AMC6-12/2500-1250/25-M5	•	•	
AMC6-12/630-630/31-M5	•	•	
AMC6-12/1250-630/31-M5	•	•	
AMC6-12/1250-1250/31-M5	•	•	
AMC6-12/2500-630/31-M5	•	•	
AMC6-12/2500-1250/31-M5	•	•	
AMC9-12/630-630/20-M5	•	•	
AMC9-12/1250-630/20-M5	•	•	
AMC9-12/1250-1250/20-M5	•	•	
AMC9-12/2500-630/20-M5	•	•	
AMC9-12/2500-1250/20-M5	•	•	
AMC9-12/630-630/25-M5	•	•	
AMC9-12/1250-630/25-M5	•	•	
AMC9-12/1250-1250/25-M5	•	•	
AMC9-12/2500-630/25-M5	•	•	
AMC9-12/2500-1250/25-M5	•	•	
AMC9-12/630-630/31-M5	•	•	
AMC9-12/1250-630/31-M5	•	•	
AMC9-12/1250-1250/31-M5	•	•	
AMC9-12/2500-630/31-M5	•	•	
AMC9-12/2500-1250/31-M5	•	•	
AMC9-12/2500-2500/20-M5	•	•	
AMC9-12/630-630/25-M5	•	•	
AMC9-12/1250-630/25-M5	•	•	
AMC9-12/1250-1250/25-M5	•	•	
AMC9-12/2500-630/25-M5	•	•	
AMC9-12/2500-1250/25-M5	•	•	
AMC9-12/2500-2500/25-M5	•	•	
AMC9-12/630-630/31-M5	•	•	
AMC9-12/1250-630/31-M5	•	•	
AMC9-12/1250-1250/31-M5	•	•	
AMC9-12/2500-630/31-M5	•	•	
AMC9-12/2500-1250/31-M5	•	•	
AMC9-12/2500-2500/31-M5	•	•	
AMC6-17/630-630/20-M5			•
AMC6-17/1250-630/20-M5			•
AMC6-17/1250-1250/20-M5			•
AMC6-17/2000-630/20-M5			•
AMC6-17/2000-1250/20-M5			•
AMC6-17/630-630/25-M5			•
AMC6-17/1250-630/25-M5			•
AMC6-17/1250-1250/25-M5			•
AMC6-17/2000-630/25-M5			•
AMC6-17/2000-1250/25-M5			•
AMC6-17/630-630/31-M5			•
AMC6-17/1250-630/31-M5			•
AMC6-17/1250-1250/31-M5			•
AMC6-17/2000-630/31-M5			•
AMC6-17/2000-1250/31-M5			•
AMC9-17/630-630/20-M5			•
AMC9-17/1250-630/20-M5			•
AMC9-17/1250-1250/20-M5			•
AMC9-17/2000-630/20-M5			•
AMC9-17/2000-1250/20-M5			•
AMC9-17/2000-2000/20-M5			•
AMC9-17/630-630/25-M5			•
AMC9-17/1250-630/25-M5			•
AMC9-17/1250-1250/25-M5			•
AMC9-17/2000-630/25-M5			•
AMC9-17/2000-1250/25-M5			•
AMC9-17/2000-2000/25-M5			•
AMC9-17/630-630/31-M5			•
AMC9-17/1250-630/31-M5			•
AMC9-17/1250-1250/31-M5			•
AMC9-17/2000-630/31-M5			•
AMC9-17/2000-1250/31-M5			•
AMC9-17/2000-2000/31-M5			•

1) Key to type references → page 9.

Medium-voltage switchgear up to 17.5 kV, air-insulated, metal-clad, withdrawable technique, Type AMC

Equipment for metering panel M5; with outgoing cables

Equipment options for AMC - metering panels M5

Type: AMC...-...../.....-...../.....-M5

Example: AMC6-12/1250-630/25-M5

For the metering panel M5 with outgoing cables there are three versions available:

- 1. Metering panel M5 - metering transformer configuration in the cable connection compartment, drawer unit compartment not used
- 2. Metering panel M5 - metering transformer configuration in the cable connection compartment, drawer unit compartment with disconnecting link
- 3. Metering panel M5 - metering transformer configuration fixed mounted in the drawer unit compartment

Low-voltage compartment¹⁾:

- height 600 mm (standard)
- height 800 mm
- door with padlock interlocking

Busbar compartment¹⁾:

- busbars / section busbars 630 A
- busbars / section busbars 1250 A
- busbars / section busbars 2500 A
- capacitive voltage detection system at busbars

Cable connection compartment¹⁾:

- outgoing busbars 630 A
- outgoing busbars 1250 A
- outgoing busbars 2500 A (only at panel width 900 mm)
- support current transformer 1 core
- support current transformer 2 cores
- support current transformer 3 cores
- voltage transformer single phase, 1 winding, rear mounted
- voltage transformer single phase, 2 windings, rear mounted
- voltage transformer single phase, 3 windings, rear mounted
- voltage measurement before current measurement, rear mounted
- voltage measurement after current measurement, rear mounted
- voltage transformer single phase, 1 winding, front mounted
- voltage transformer single phase, 2 windings, front mounted
- voltage transformer single phase, 1 winding, with primary fuse up to 10 kV, front mounted
- voltage transformer single phase, 2 windings, with primary fuse up to 10 kV, front mounted
- surge arrester up to 10 kV at outgoing, front mounted
- cable connection 1 system per phase
- cable connection 2 systems per phase
- cable connection 3 systems per phase
- cable connection 4 systems per phase (only at panel width 900 mm)
- cable connection 5 systems per phase (only at panel width 900 mm)
- cable connection 6 systems per phase (only at panel width 900 mm)
- cable lug termination M12
- cable lug termination M16
- cable clamp size 1 (→ page 7)
- cable clamp size 2 (→ page 7)
- ball terminal bolt 25 mm, L1-L3 and panel fixing point for earthing
- door with padlock interlocking
- capacitive voltage detection system at outgoing cable

Panel extension above^{1) 4)}:

- busbar voltage transformer single phase up to 10 kV, 1 winding; up to 25 kA (only at panel width 650 mm)
- busbar voltage transformer single phase up to 10 kV, 2 windings; up to 25 kA (only at panel width 650 mm)
- busbar earthing switch³⁾ up to 10 kV, 25 kA, manual operation; (only at panel width 650 mm)
- busbar earthing switch³⁾ up to 10 kV, 25 kA, manual operation with electro-mechanical interlocking; (only at panel width 650 mm)
- surge arrester at busbars up to 10 kV, 25 kA (only at panel width 650 mm)
- arc absorber assembly (standard equipment for AMC9)

Equipment compartment¹⁾:

- disconnecting link²⁾ 630 A, with electro-mechanical interlocking to drawer movement; (only for version 2)
- disconnecting link²⁾ 1250 A, with electro-mechanical interlocking to drawer movement; (only for version 2)
- disconnecting link²⁾ 2500 A, with electro-mechanical interlocking to drawer movement; (only for version 2)
- support current transformer 1 core; (only for version 3)
- support current transformer 2 cores; (only for version 3)
- voltage transformer single phase, 1 winding; (only for version 3)
- voltage transformer single phase, 2 windings; (only for version 3)
- voltage measurement before current measurement; (only for version 3)
- voltage measurement after current measurement; (only for version 3)
- panel connection bolt M16 for earthing drawer unit / manual; (only for version 2)
- door without operation opening (only for version 2)
- door with padlock interlocking
- door interlocking with drawer unit position, mechanical; (only for version 2)
- door interlocking electro-mechanical

Panel covers above¹⁾:

- arc-deflecting shield 500 mm (standard)
- pressure relief channel in panel partition (panel height 2900 mm) without channel from the switchgear room

Auxiliary voltages electro-mechanical interlocking and controls (only for version 2):

- 24 V DC
- 48 V DC
- 60 V DC
- 110 V DC
- 220 V DC
- 110 V AC
- 230 V AC

Control systems:

- standard control circuit
- customer-specific control circuit

Customer-specific current and voltage transformers:

Ratings:

- 1) Mounting positions for equipment → page 8
Only one equipment variant can be assembled at each mounting position.
- 2) Equipment of disconnecting link → pages 38 and 39
- 3) Equipment of earthing switch → pages 42 and 43
- 4) Not possible when panel cover above option pressure relief channel is used

Medium-voltage switchgear up to 17.5 kV, air-insulated, metal-clad, withdrawable technique, Type AMC

Delivery programme metering panel M6; busbar voltage measurement

Delivery programme metering panel M6; busbar voltage measurement

For the metering panel M6 busbar voltage measurement there are two versions available:

1. Metering panel M6 - metering transformer configuration in the cable connection compartment, drawer unit compartment with vacuum load-break switch
2. Metering panel M6 - metering transformer configuration in the cable connection compartment, drawer unit compartment not used

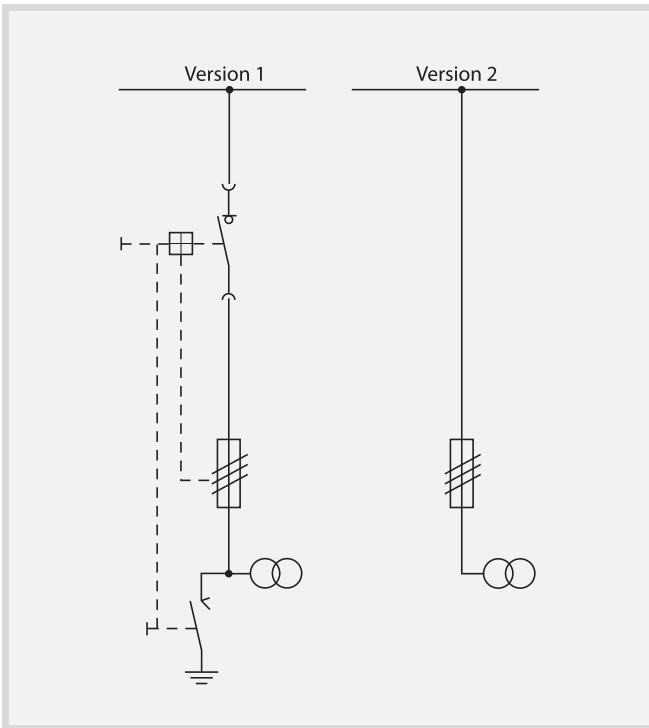

Configuration example for panel type ...-M6
Other equipment options → page 25.

Technical data and dimensions²⁾:

		Rated voltage U_r [kV]	
		7.2	12
Rated normal current I_r	A	200	200
Panel height			
Standard incl. arc-deflecting shield	mm	2700	2700
with pressure relief channel	mm	2900	2900
Panel depth			
	mm	1400	1400
Panel width			
	mm	650	650

2) Additional technical data → pages 9 and 11.

Panel types ¹⁾	Rated voltage U_r [kV]	
	7.2	12
AMC6-12/630-200/20-M6	•	•
AMC6-12/1250-200/20-M6	•	•
AMC6-12/2500-200/20-M6	•	•
AMC6-12/630-200/25-M6	•	•
AMC6-12/1250-200/25-M6	•	•
AMC6-12/2500-200/25-M6	•	•
AMC6-12/630-200/31-M6	•	•
AMC6-12/1250-200/31-M6	•	•
AMC6-12/2500-200/31-M6	•	•

1) Key to type references → page 9.

The rated short-time withstand current I_r at the outgoing busbars is limited by the HRC fuses.

The three-phase tripping of the load-break switch (optional) is performed electrically by the auxiliary contacts of the fuse base and the load-break switch trip element.

At HRC fuse base high-voltage fuses for voltage transformers according to DIN 43625 and IEC 60282-1, dimension $e = 292$ mm, $d = 53$ mm, rated current 1 A up to 4 A can be implemented.

Medium-voltage switchgear up to 17.5 kV, air-insulated, metal-clad, withdrawable technique, Type AMC

Equipment for metering panel M6; busbar voltage measurement

Equipment for metering panel M6; busbar voltage measurement

Equipment options for AMC - metering panels M6 for busbar voltage measurement

For the metering panel M6 with outgoing cables there are two versions available:

- 1. Metering panel M6 - metering transformer configuration in the cable connection compartment, drawer unit compartment with vacuum load-break switch
- 2. Metering panel M6 - metering transformer configuration in the cable connection compartment, drawer unit compartment not used

Low-voltage compartment¹⁾:

- height 600 mm (standard)
- height 800 mm
- door with padlock interlocking

Busbar compartment¹⁾:

- busbars 630 A
- busbars 1250 A
- busbars 2500 A
- capacitive voltage detection system at busbars

Voltage transformer compartment¹⁾:

- voltage transformer single phase, 1 winding, rear mounted
- voltage transformer single phase, 2 windings, rear mounted
- voltage transformer single phase, 3 windings, rear mounted
- HRC fuse base 3ph with auxiliary contacts 1NO + 1NC for tripping or indication, for HRC fuses e = 292 mm, d = 53 mm
- earthing switch³⁾, manual operation (only for version 1)
- earthing switch³⁾, manual operation with electro-mechanical interlocking (only for version 1)
- earthing switch with motorised drive³⁾ (only for version 1)
- door with padlock interlocking
- door interlocking by earthing switch (only for version 1)
- door interlocking electro-mechanical
- capacitive voltage detection system at outgoing cable

Drawer unit compartment¹⁾:

- vacuum-load-break switch 630 A²⁾ (only for version 1)
- panel connection bolt M16 for earthing drawer unit / manual; (only for version 1)
- door with manual switch operation (only for version 1)
- door with manual switch operation, padlock interlocking (only for version 1)
- door without operation opening (only for version 1)
- door with padlock interlocking
- door interlocking with drawer unit position, mechanical; (only for version 1)
- door interlocking electro-mechanical (only for version 1)
- drawer unit with mechanical interlocking to the earthing switch (only for version 1)
- drawer unit with mechanical interlocking to the earthing switch and motorised drive for drawer movement (only for version 1)
- drawer unit with mechanical interlocking to the earthing switch and electro-mechanical interlocking to the drawer movement (only for version 1)

Panel extension above^{1) 4)}:

- busbar voltage transformer single phase up to 10 kV, 1 winding; up to 25 kA
- busbar voltage transformer single phase up to 10 kV, 2 windings; up to 25 kA
- busbar earthing switch³⁾ up to 10 kV, 25 kA, manual operation
- busbar earthing switch³⁾ up to 10 kV, 25 kA, manual operation with electro-mechanical interlocking
- surge arrester at busbars up to 10 kV, 25 kA
- arc absorber assembly

Type: AMC6-12/.....-200/.....-M6

Example: AMC6-12/1250-200/25-M6

Panel covers above¹⁾:

- arc-deflecting shield 500 mm (standard)
- pressure relief channel in panel partition (panel height 2900 mm) without channel from the switchgear room

Standard protection and control system:

- panel control system
- standard control circuit
- customer-specific control circuit

Auxiliary voltages for motorised drives, electro-mechanical interlocking and controls:

- 24 V DC
- 48 V DC
- 60 V DC
- 110 V DC
- 220 V DC
- 110 V AC
- 230 V AC

Customer-specific voltage transformers:

Ratings:

-
-
-
- 1) Mounting positions for equipment → page 8
Only one equipment variant can be assembled at each mounting position.
 - 2) Equipment of switch → pages 36 and 37
 - 3) Equipment of earthing switch → pages 42 and 43
 - 4) Not possible when panel cover above option pressure relief channel is used

Medium-voltage switchgear up to 17.5 kV, air-insulated, metal-clad, withdrawable technique, Type AMC

Delivery programme bus sectionaliser riser panel

Delivery programme bus sectionaliser riser panel

For section busbar riser panels HG there are two versions available:

1. Bus sectionaliser riser panel HG - drawer unit compartment not used
2. Bus sectionaliser riser panel HG - drawer unit compartment with disconnecting link

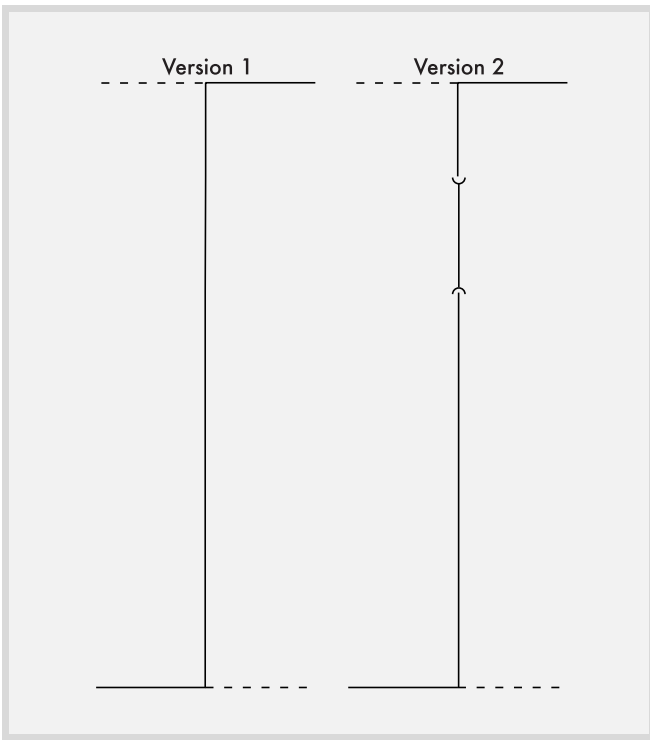

Configuration example for panel type ...-HG
Other equipment options → page 27.

Technical data and dimensions²⁾:

		Rated voltage U_r [kV]		
		7.2	12	17.5
Rated current I_r for main busbars and section busbars	A	630	630	630
	A	1250	1250	1250
	A	2500	2500	2000
Panel height				
Standard incl. arc-deflecting shield	mm	2700	2700	2700
with pressure relief channel	mm	2900	2900	2900
Panel depth				
	mm	1400	1400	1400
Panel width for I_r				
≤ 1250 A	mm	650/ 900	650/ 900	650/ 900
> 1250 A up to 2500 A	mm	900	900	900

2) Additional technical data → pages 9 and 11.

Panel types ¹⁾	Rated voltage U_r [kV]		
	7.2	12	17.5
AMC6-12/630-630/20-HG	•	•	
AMC6-12/630-630/25-HG	•	•	
AMC6-12/630-630/31-HG	•	•	
AMC6-12/1250-1250/20-HG	•	•	
AMC6-12/1250-1250/25-HG	•	•	
AMC6-12/1250-1250/31-HG	•	•	
AMC9-12/630-630/20-HG	•	•	
AMC9-12/630-630/25-HG	•	•	
AMC9-12/630-630/31-HG	•	•	
AMC9-12/1250-1250/20-HG	•	•	
AMC9-12/1250-1250/25-HG	•	•	
AMC9-12/1250-1250/31-HG	•	•	
AMC9-12/2500-2500/20-HG	•	•	
AMC9-12/2500-2500/25-HG	•	•	
AMC9-12/2500-2500/31-HG	•	•	
AMC6-17/630-630/20-HG			•
AMC6-17/630-630/25-HG			•
AMC6-17/630-630/31-HG			•
AMC6-17/1250-1250/20-HG			•
AMC6-17/1250-1250/25-HG			•
AMC6-17/1250-1250/31-HG			•
AMC9-17/630-630/20-HG			•
AMC9-17/630-630/25-HG			•
AMC9-17/630-630/31-HG			•
AMC9-17/1250-1250/20-HG			•
AMC9-17/1250-1250/25-HG			•
AMC9-17/1250-1250/31-HG			•
AMC9-17/2000-2000/20-HG			•
AMC9-17/2000-2000/25-HG			•
AMC9-17/2000-2000/31-HG			•

1) Key to type references → page 9.

Medium-voltage switchgear up to 17.5 kV, air-insulated, metal-clad, withdrawable technique, Type AMC

Equipment for bus sectionaliser riser panel

Equipment for bus sectionaliser riser panel

Equipment options for AMC - section busbar riser panels HG

Type: AMC...-...../.....-...../.....-HG

Example: AMC6-12/1250-1250/25-HG

For section busbar riser panels HG there are two versions available:

- 1. Bus sectionaliser riser panel HG - drawer unit compartment not used
- 2. Bus sectionaliser riser panel HG - drawer unit compartment with disconnecting link

Low-voltage compartment¹⁾:

- height 600 mm (standard)
- height 800 mm
- door with padlock interlocking

Busbar compartment¹⁾:

- busbars / section busbars 630 A
- busbars / section busbars 1250 A
- busbars / section busbars 2500 A
- capacitive voltage detection system at busbars

Bus sectionaliser compartment¹⁾:

- surge arrester up to 10 kV at section busbar, front mounted
- ball terminal bolt 25 mm, L1-L3 and panel fixing point for earthing
- door with padlock interlocking
- capacitive voltage detection system at section busbars

Panel extension above^{1) 4)}:

- busbar voltage transformer single phase up to 10 kV, 1 winding; up to 25 kA (only at panel width 650 mm)
- busbar voltage transformer single phase up to 10 kV, 2 windings; up to 25 kA (only at panel width 650 mm)
- busbar earthing switch³⁾ up to 10 kV, 25 kA, manual operation; (only at panel width 650 mm)
- busbar earthing switch³⁾ up to 10 kV, 25 kA, manual operation with electro-mechanical interlocking; (only at panel width 650 mm)
- surge arrester at busbars up to 10 kV, 25 kA (only at panel width 650 mm)
- arc absorber assembly (standard equipment for AMC9)

Drawer unit compartment¹⁾:

- disconnecting link²⁾ 630 A, with electro-mechanical interlocking to drawer movement; (only for version 2)
- disconnecting link²⁾ 1250 A, with electro-mechanical interlocking to drawer movement; (only for version 2)
- disconnecting link²⁾ 2500 A, with electro-mechanical interlocking to drawer movement; (only for version 2)
- panel connection bolt M16 for earthing drawer unit / manual; (only for version 2)
- door without operation opening (only for version 2)
- door with padlock interlocking
- door interlocking with disconnecting link position, mechanical; (only for version 2)
- door interlocking electro-mechanical

Panel covers above¹⁾:

- arc-deflecting shield 500 mm (standard)
- pressure relief channel in panel partition (panel height 2900 mm) without channel from the switchgear room

Auxiliary voltages for electro-mechanical interlocking and control (only for version 2):

- 24 V DC
- 48 V DC
- 60 V DC
- 110 V DC
- 220 V DC
- 110 V AC
- 230 V AC

Control systems:

- standard control circuit
- customer-specific control circuit

- 1) Mounting positions for equipment → page 8
Only one equipment variant can be assembled at each mounting position.
- 2) Equipment of these devices → pages 38 and 39
- 3) Equipment of earthing switch → pages 42 and 43
- 4) Not possible when panel cover above option pressure relief channel is used

Medium-voltage switchgear up to 17.5 kV, air-insulated, metal-clad, withdrawable technique, Type AMC

Delivery programme busbar riser panel; with cable connection

Delivery programme busbar riser panel; with cable connection

For busbar riser panels with cable connections there are two versions available:

1. Busbar riser panel H - drawer unit compartment not used
2. Busbar riser panel H - drawer unit compartment with disconnecting link

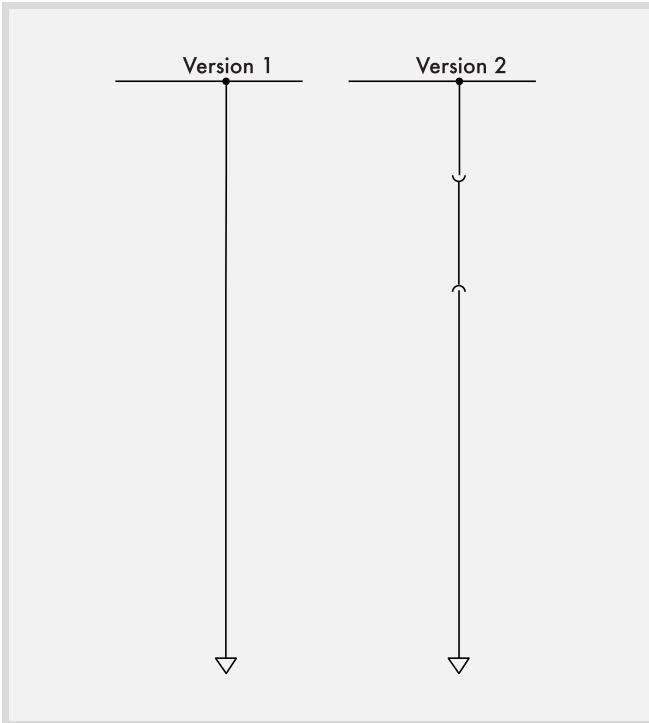

Configuration example for panel type ...-H
Other equipment options → page 29.

Technical data and dimensions²⁾:

		Rated voltage U_r [kV]		
		7.2	12	17.5
Rated normal current I_r for outgoing busbars	A	630	630	630
	A	1250	1250	1250
	A	2500	2500	2000
Panel height				
Standard incl. arc-deflecting shield	mm	2700	2700	2700
with pressure relief channel	mm	2900	2900	2900
Panel depth				
	mm	1400	1400	1400
Panel width for I_r				
≤ 1250 A	mm	650/ 900	650/ 900	650/ 900
> 1250 A up to 2500 A	mm	900	900	900

2) Additional technical data → pages 9 and 11.

Panel types ¹⁾	Rated voltage U_r [kV]		
	7.2	12	17.5
AMC6-12/630-630/20-H	•	•	
AMC6-12/1250-630/20-H	•	•	
AMC6-12/1250-1250/20-H	•	•	
AMC6-12/2500-630/20-H	•	•	
AMC6-12/2500-1250/20-H	•	•	
AMC6-12/630-630/25-H	•	•	
AMC6-12/1250-630/25-H	•	•	
AMC6-12/1250-1250/25-H	•	•	
AMC6-12/2500-630/25-H	•	•	
AMC6-12/2500-1250/25-H	•	•	
AMC6-12/630-630/31-H	•	•	
AMC6-12/1250-630/31-H	•	•	
AMC6-12/1250-1250/31-H	•	•	
AMC6-12/2500-630/31-H	•	•	
AMC6-12/2500-1250/31-H	•	•	
AMC9-12/630-630/20-H	•	•	
AMC9-12/1250-630/20-H	•	•	
AMC9-12/2500-630/20-H	•	•	
AMC9-12/2500-1250/20-H	•	•	
AMC9-12/2500-2500/20-H	•	•	
AMC9-12/630-630/25-H	•	•	
AMC9-12/1250-630/25-H	•	•	
AMC9-12/1250-1250/25-H	•	•	
AMC9-12/2500-630/25-H	•	•	
AMC9-12/2500-1250/25-H	•	•	
AMC9-12/2500-2500/25-H	•	•	
AMC9-12/630-630/31-H	•	•	
AMC9-12/1250-630/31-H	•	•	
AMC9-12/1250-1250/31-H	•	•	
AMC9-12/2500-630/31-H	•	•	
AMC9-12/2500-1250/31-H	•	•	
AMC9-12/2500-2500/31-H	•	•	
AMC6-17/630-630/20-H			•
AMC6-17/1250-630/20-H			•
AMC6-17/1250-1250/20-H			•
AMC6-17/2000-630/20-H			•
AMC6-17/2000-1250/20-H			•
AMC6-17/630-630/25-H			•
AMC6-17/1250-630/25-H			•
AMC6-17/1250-1250/25-H			•
AMC6-17/2000-630/25-H			•
AMC6-17/2000-1250/25-H			•
AMC6-17/630-630/31-H			•
AMC6-17/1250-630/31-H			•
AMC6-17/1250-1250/31-H			•
AMC6-17/2000-630/31-H			•
AMC6-17/2000-1250/31-H			•
AMC9-17/630-630/20-H			•
AMC9-17/1250-630/20-H			•
AMC9-17/1250-1250/20-H			•
AMC9-17/2000-630/20-H			•
AMC9-17/2000-1250/20-H			•
AMC9-17/2000-2000/20-H			•
AMC9-17/630-630/25-H			•
AMC9-17/1250-630/25-H			•
AMC9-17/1250-1250/25-H			•
AMC9-17/2000-630/25-H			•
AMC9-17/2000-1250/25-H			•
AMC9-17/2000-2000/25-H			•
AMC9-17/630-630/31-H			•
AMC9-17/1250-630/31-H			•
AMC9-17/1250-1250/31-H			•
AMC9-17/2000-630/31-H			•
AMC9-17/2000-1250/31-H			•
AMC9-17/2000-2000/31-H			•

1) Key to type references → page 9.

Medium-voltage switchgear up to 17.5 kV, air-insulated, metal-clad, withdrawable technique, Type AMC

Equipment for busbar riser panel; with cable connection

Equipment for busbar riser panel; with cable connection

Equipment options for AMC - busbar riser panels H

Type: AMC...-...../.....-...../.....-H

Example: AMC9-12/2500-1250/25-H

For busbar riser panels with cable connections there are two versions available:

- 1. Busbar riser panel H - drawer unit compartment not used
- 2. Busbar riser panel H - drawer unit compartment with disconnecting link

Low-voltage compartment¹⁾:

- height 600 mm (standard)
- height 800 mm
- door with padlock interlocking

Busbar compartment¹⁾:

- busbars / section busbars 630 A
- busbars / section busbars 1250 A
- busbars / section busbars 2500 A
- capacitive voltage detection system at busbars

Cable connection compartment¹⁾:

- outgoing busbars 630 A
- outgoing busbars 1250 A
- outgoing busbars 2500 A (only at panel width 900 mm)
- surge arrester up to 10 kV at outgoing, front mounted
- cable connection 1 system per phase
- cable connection 2 systems per phase
- cable connection 3 systems per phase
- cable connection 4 systems per phase (only at panel width 900 mm)
- cable connection 5 systems per phase (only at panel width 900 mm)
- cable connection 6 systems per phase (only at panel width 900 mm)
- cable lug termination M12
- cable lug termination M16
- cable clamp size 1 (→ page 7)
- cable clamp size 2 (→ page 7)
- ball terminal bolt 25 mm, L1-L3 and panel fixing point for earthing
- door with padlock interlocking
- capacitive voltage detection system at outgoing cable

Panel extension above^{1) 4)}:

- busbar voltage transformer single phase up to 10 kV, 1 winding; up to 25 kA (only at panel width 650 mm)
- busbar voltage transformer single phase up to 10 kV, 2 windings; up to 25 kA (only at panel width 650 mm)
- busbar earthing switch³⁾ up to 10 kV, 25 kA, manual operation; (only at panel width 650 mm)
- busbar earthing switch³⁾ up to 10 kV, 25 kA, manual operation with electro-mechanical interlocking; (only at panel width 650 mm)
- surge arrester at busbars up to 10 kV, 25 kA (only at panel width 650 mm)
- arc absorber assembly (standard equipment for AMC9)

Drawer unit compartment¹⁾:

- disconnecting link²⁾ 630 A, with electro-mechanical interlocking to drawer movement; (only for version 2)
- disconnecting link²⁾ 1250 A, with electro-mechanical interlocking to drawer movement; (only for version 2)
- disconnecting link²⁾ 2500 A, with electro-mechanical interlocking to drawer movement; (only for version 2)
- panel connection bolt M16 for earthing drawer unit / manual; (only for version 2)
- door without operation opening (only for version 2)
- door with padlock interlocking
- door interlocking with disconnecting link position, mechanical; (only for version 2)
- door interlocking electro-mechanical

Panel covers above¹⁾:

- arc-deflecting shield 500 mm (standard)
- pressure relief channel in panel partition (panel height 2900 mm) without channel from the switchgear room

Auxiliary voltages for electro-mechanical interlocking and controls (only for version 2):

- 24 V DC
- 48 V DC
- 60 V DC
- 110 V DC
- 220 V DC
- 110 V AC
- 230 V AC

Control systems:

- standard control circuit
- customer-specific control circuit

- 1) Mounting positions for equipment → page 8
Only one equipment variant can be assembled at each mounting position.
- 2) Equipment of these devices → pages 38 and 39
- 3) Equipment of earthing switch → pages 42 and 43
- 4) Not possible when panel cover above option pressure relief channel is used

Medium-voltage switchgear up to 17.5 kV, air-insulated, metal-clad, withdrawable technique, Type AMC

Delivery programme busbars earthing panel

Delivery programme busbars earthing panel

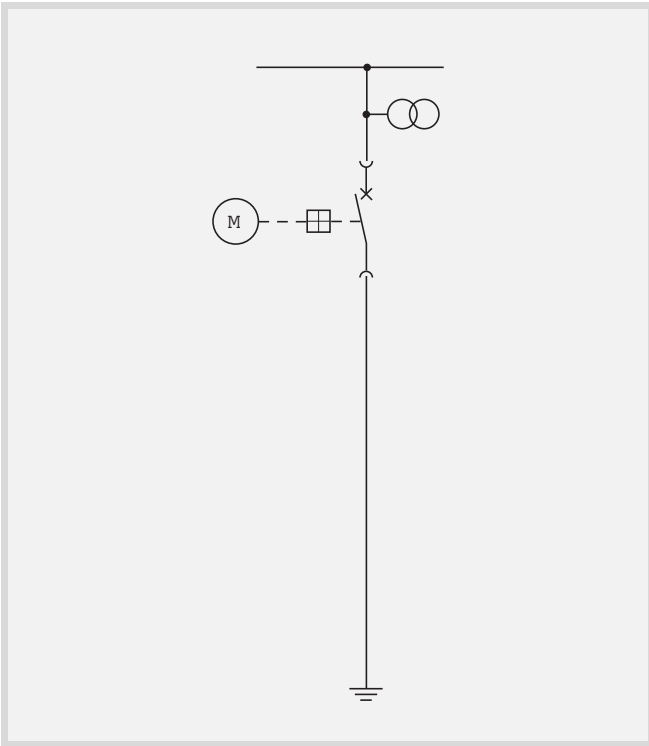

Configuration example for panel type ...-E
Other equipment options → page 31.

Panel types ¹⁾	Rated voltage U_r [kV]	
	7.2	12
AMC6-12/630-200/20-E	•	•
AMC6-12/1250-200/20-E	•	•
AMC6-12/2500-200/20-E	•	•
AMC6-12/630-200/25-E	•	•
AMC6-12/1250-200/25-E	•	•
AMC6-12/2500-200/25-E	•	•
AMC6-12/630-200/31-E	•	•
AMC6-12/1250-200/31-E	•	•
AMC6-12/2500-200/31-E	•	•

1) Key to type references → page 9.

The busbar earthing panel offers additional configuration options for a busbar voltage measurement and for the connection of surge arrestors. As switch a vacuum circuit-breaker is used.

Technical data and dimensions²⁾:

		Rated voltage U_r [kV]	
		7.2	12
Rated normal current I_r	A	200	200
Panel height			
Standard incl. arc-deflecting shield	mm	2700	2700
with pressure relief channel	mm	2900	2900
Panel depth			
	mm	1400	1400
Panel width			
	mm	650	650

2) Additional technical data → pages 9 and 11.

Medium-voltage switchgear up to 17.5 kV, air-insulated, metal-clad, withdrawable technique, Type AMC

Equipment for busbar earthing panel

Equipment for busbar earthing panel

Equipment options for AMC - busbar earthing panels

Low-voltage compartment¹⁾:

- height 600 mm (standard)
- height 800 mm
- door with padlock interlocking

Busbar compartment¹⁾:

- busbars 630 A
- busbars 1250 A
- busbars 2500 A
- capacitive voltage detection system at busbars

Voltage transformer compartment¹⁾:

- voltage transformer single phase, 1 winding, rear mounted
- voltage transformer single phase, 2 windings, rear mounted
- voltage transformer single phase, 3 windings, rear mounted
- voltage transformer single phase, 1 winding, front mounted
- voltage transformer single phase, 2 windings, front mounted
- voltage transformer single phase, 1 winding, with primary fuse up to 10 kV, front mounted
- voltage transformer single phase, 2 windings, with primary fuse up to 10 kV, front mounted
- surge arrester up to 10 kV, at main busbar
- door with padlock interlocking
- electro-mechanical door interlocking
- capacitive voltage detection system at busbars

Panel extension above^{1) 3)}:

- arc absorber assembly

Drawer unit compartment¹⁾:

- vacuum circuit-breaker 630 A²⁾
- panel connection bolt M16 for earthing drawer unit / manual
- door with manual switch operation
- door with manual switch operation, padlock interlocking
- door without operation opening
- door with padlock interlocking
- door interlocking with drawer unit position, mechanical
- door interlocking electro-mechanical.
- electro-mechanical interlocking to the drawer movement
- drawer unit with motorised drive for drawer movement

Panel covers above¹⁾:

- arc-deflecting shield 500 mm (standard)
- pressure relief channel in panel partition (panel height 2900 mm) without channel from the switchgear room

Standard protection and control system:

- panel control system
- standard control circuit
- customer-specific control circuit

Type: AMC6-12/.....-200/.....-E

Example: AMC6-12/2500-200/31-E

Auxiliary voltages for motorised drives, electro-mechanical interlocking and controls:

- 24 V DC
- 48 V DC
- 60 V DC
- 110 V DC
- 220 V DC
- 110 V AC
- 230 V AC

Customer-specific voltage transformers:

Ratings:

.....

.....

.....

- 1) Mounting positions for equipment → page 8
Only one equipment variant can be assembled at each mounting position.
- 2) Equipment of switch → pages 34 and 35
- 3) Not possible when panel cover above option pressure relief channel is used

Medium-voltage switchgear up to 17.5 kV, air-insulated, metal-clad, withdrawable technique, Type AMC

Delivery programme contactor panel

Delivery programme contactor panel

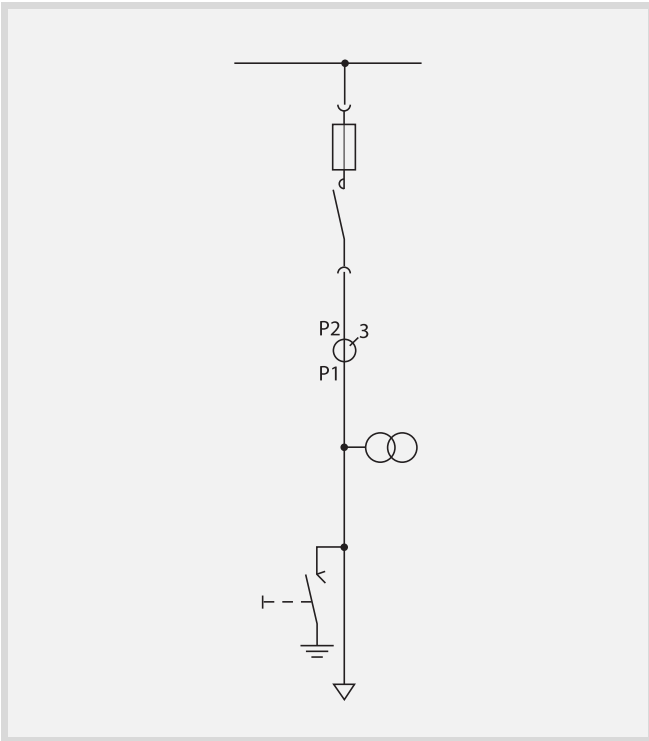

Configuration example for panel type ...-S
Other equipment options → page 33.

Technical data and dimensions²⁾:

		Rated voltage U_r [kV]
		7.2
Rated normal current I_r for outgoing busbars (continuous current)	A	200
Panel height		
Standard incl. arc-deflecting shield	mm	2700
with pressure relief channel	mm	2900
Panel depth		
	mm	1400
Panel width		
	mm	650

2) Additional technical data → pages 9 and 11.

Panel types ¹⁾	Rated voltage U_r [kV]
	7.2
AMC6-7/630-200/20-S	•
AMC6-7/1250-200/20-S	•
AMC6-7/2500-200/20-S	•
AMC6-7/630-200/25-S	•
AMC6-7/1250-200/25-S	•
AMC6-7/2500-200/25-S	•
AMC6-7/630-200/31-S	•
AMC6-7/1250-200/31-S	•
AMC6-7/2500-200/31-S	•

1) Key to type references → page 9.

The rated short-time withstand current I_k at the outgoing busbars is limited by the HRC fuses.

The three-phase tripping of the vacuum contactor is performed electrically by the auxiliary contacts of the fuse base and/or the vacuum contactor trip element.

At HRC fuse base high-voltage fuses 3/7.2 kV according to DIN 43625 and IEC 60282-1, dimension $e = 292$ mm, $d =$ up to 85 mm can be implemented.

For HRC fuse application recommendation see fuse selection table for AMC6-7/...-200/...-S panel.

AMC contactor panels are often used for switching medium-voltage motors. For additional protection of motor ≤ 55 kW surge arrestors are assembled.

As standard the vacuum contactors are equipped with latched operating circuit.

Medium-voltage switchgear up to 17.5 kV, air-insulated, metal-clad, withdrawable technique, Type AMC

Equipment for contactor panel

Equipment for contactor panel

Equipment options for AMC - contactor panels

Low-voltage compartment¹⁾:

- height 600 mm (standard)
- height 800 mm
- door with padlock interlocking

Busbar compartment¹⁾:

- busbars 630 A
- busbars 1250 A
- busbars 2500 A
- capacitive voltage detection system at busbars

Cable connection compartment¹⁾:

- outgoing busbars 200 A; continuous current rating
- support current transformer 1 core
- support current transformer 2 cores
- support current transformer 3 cores
- voltage transformer single phase, 1 winding, rear mounted
- voltage transformer single phase, 2 windings, rear mounted
- voltage transformer single phase, 3 windings, rear mounted
- voltage measurement before current measurement, rear mounted
- voltage measurement after current measurement, rear mounted
- fixed compensation 3ph up to 133 kVAR, 7.2 kV³⁾
- earthing switch⁵⁾, manual operation
- earthing switch⁵⁾, manual operation with electro-mechanical interlocking
- earthing switch with motorised drive⁵⁾
- voltage transformer single phase, 1 winding, front mounted
- voltage transformer single phase, 2 windings, front mounted
- voltage transformer single phase, 1 winding, with primary fuse up to 6.6 kV, front mounted
- voltage transformer single phase, 2 windings, with primary fuse up to 6.6 kV, front mounted
- outgoing cable surge arrester up to 6.6 kV, front mounted
- cable connection 1 system per phase
- cable connection 2 systems per phase
- cable connection 3 systems per phase
- cable lug termination M12
- cable lug termination M16
- cable clamp size 1 (→ page 7)
- cable clamp size 2 (→ page 7)
- ball terminal bolt 25 mm, L1-L3 and panel fixing point for earthing
- door with padlock interlocking
- door interlocking by earthing switch
- door interlocking electro-mechanical.
- capacitive voltage detection system at outgoing cable

Panel extension above^{1) 6)}:

- busbar voltage transformers single phase up to 6.6 kV, 1 winding; up to 25 kA
- busbar voltage transformers single phase up to 6.6 kV, 2 windings; up to 25 kA
- busbar earthing switch⁵⁾ up to 6.6 kV, 25 kA, manual operation
- busbar earthing switch⁵⁾ up to 6.6 kV, 25 kA, manual operation with electro-mechanical interlocking
- surge arrester at busbars up to 6.6 kV, 25 kA
- arc absorber assembly

Type: AMC6-7/.....-200/.....-S

Example: AMC6-7/1250-200/25-S

Drawer unit compartment¹⁾:

- vacuum contactor incl. HRC fuse base²⁾
- fan unit for forced-air ventilation⁴⁾
- panel connection bolt M16 for earthing drawer unit / manual
- door with manual contactor operation OFF
- door with manual contactor operation OFF, padlock interlocking
- door without operation opening
- door with padlock interlocking
- door interlocking with drawer unit position, mechanical
- door interlocking electro-mechanical.
- drawer unit with mechanical interlocking to the earthing switch
- drawer unit with mechanical interlocking to the earthing switch and electro-mechanical interlocking to the drawer movement

Panel covers above¹⁾:

- arc-deflecting shield 500 mm (standard)
- pressure relief channel in panel partition (panel height 2900 mm) without channel from the switchgear room

Standard protection and control system:

- panel control system with integral time overcurrent protection
- standard control circuit with time overcurrent protection
- standard control circuit with basic motor protection
- customer-specific protection and control systems

Auxiliary voltages for motorised drive electro-mechanical interlocking and controls:

- 24 V DC
- 48 V DC
- 60 V DC
- 110 V DC
- 220 V DC
- 110 V AC
- 230 V AC

Auxiliary voltages for fan unit:

- 110 V AC
- 230 V AC

Customer-specific current and voltage transformers:

Ratings:

.....

.....

.....

- 1) Mounting positions for equipment → page 8
Only one equipment variant can be assembled at each mounting position.
- 2) Equipment of contactor → pages 40 and 41
- 3) Only one cable connection per phase possible
- 4) Necessary for applications with MV motors ≥ 1000 kW
- 5) Equipment of earthing switch → pages 42 and 43
- 6) Not possible when panel cover above option pressure relief channel is used

Medium-voltage switchgear up to 17.5 kV, air-insulated, metal-clad, withdrawable technique, Type AMC

Delivery programme vacuum circuit-breaker drawer unit

Delivery programme vacuum circuit-breaker drawer unit

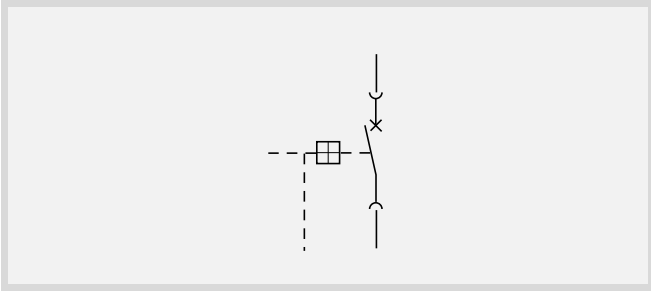

Technical data²⁾: optional

		Rated voltage U_r [kV]		
		7.2	12	17.5
Rated normal current I_r	A	630	630	630
	A	1250	1250	1250
	A	2500	2500	2000
Rated-short circuit-breaking current I_{sc} and short-time current I_k , at $t_k = 3$ s	kA	20	20	20
	kA	25	25	25
	kA	31.5	31.5	31.5
Rated peak withstand current I_p	kA	50	50	50
	kA	62.5	62.5	62.5
	kA	80	80	80
Rated switching sequence		0 - 0,3 s - C0 - 15 s - C0		
Class		E1, C2, M2		
Mechanical switching operations		10000 x		

2) Additional technical data → page 11.

Circuit-breaker types ¹⁾	Installation	Rated voltage U_r [kV]		
		7.2	12	17.5
NVL2F-12/20/630-150C	AMC6	•	•	
NVL2F-12/25/630-150C	AMC6	•	•	
NVL2F-12/31/630-150C	AMC6	•	•	
NVL2F-12/20/1250-150C	AMC6	•	•	
NVL2F-12/25/1250-150C	AMC6	•	•	
NVL2F-12/31/1250-150C	AMC6	•	•	
NVL2F-12/20/630-210C	AMC9	•	•	
NVL2F-12/25/630-210C	AMC9	•	•	
NVL2F-12/31/630-210C	AMC9	•	•	
NVL2F-12/20/1250-210C	AMC9	•	•	
NVL2F-12/25/1250-210C	AMC9	•	•	
NVL2F-12/31/1250-210C	AMC9	•	•	
NVL3F-12/20/2500-210C	AMC9	•	•	
NVL3F-12/25/2500-210C	AMC9	•	•	
NVL3F-12/31/2500-210C	AMC9	•	•	
NVL2F-17/20/630-150C	AMC6			•
NVL2F-17/25/630-150C	AMC6			•
NVL2F-17/31/630-150C	AMC6			•
NVL2F-17/20/1250-150C	AMC6			•
NVL2F-17/25/1250-150C	AMC6			•
NVL2F-17/31/1250-150C	AMC6			•
NVL2F-17/20/630-210C	AMC9			•
NVL2F-17/25/630-210C	AMC9			•
NVL2F-17/31/630-210C	AMC9			•
NVL2F-17/20/1250-210C	AMC9			•
NVL2F-17/25/1250-210C	AMC9			•
NVL2F-17/31/1250-210C	AMC9			•
NVL3F-17/20/2000-210C	AMC9			•
NVL3F-17/25/2000-210C	AMC9			•
NVL3F-17/31/2000-210C	AMC9			•

1) Key to type references → page 9.

Medium-voltage switchgear up to 17.5 kV, air-insulated, metal-clad, withdrawable technique, Type AMC

Equipment for vacuum circuit-breaker drawer unit

Equipment for vacuum circuit-breaker drawer unit

Equipment options for AMC vacuum circuit-breaker drawer units

Type: NVL...F-.../.../.....-.....C

Example: NVL2F-12/25/1250-150C

Standard equipment of circuit-breakers:

- charged spring drive with manual actuation
- trip element "ON"
- 1. trip element "OFF"
- 64-pin plug connector with mechanical interlocking
- auxiliary contacts 5 NO + 5 NC (4 NO + 5 NC free available)
- fleeting contact switch message "OFF"
- mechanical counter
- contact arms
- mechanical push-buttons "ON" and "OFF"
- mechanical position indicator
- mechanical spring charge indicator

Additional equipment for circuit-breakers¹⁾:

- motorised accumulator drive incl. trip element "ON", annunciator switch for spring charging, anti-pumping relay
- 2. trip element "OFF"
- 3. trip element "OFF" with auxiliary contacts, extension 5 NO + 5 NC
- transformer operated trip, alternative to 1. or 2. trip element
- undervoltage release, 100 V AC (non-delayed) alternative to 2. trip element
- auxiliary contact extension 5 NO + 5 NC
- message spring accumulator tensioned
- electric closing lock-out

Standard equipment for drawer units:

- mechanical drawer movement, manual operation
- mechanical interlocking to the earthing switch
- mechanical button actuation for circuit-breaker push-button
- auxiliary contacts position "Disconnected position" 3 change-over contacts (2 free available)
- auxiliary contacts position "Connected position" 3 change-over contacts (2 free available)

Additional equipment for drawer unit¹⁾:

- motorised drive for drawer movement
- electro-mechanical interlocking for drawer movement

1) Further accessories on request

Auxiliary voltages for circuit-breaker	24 V DC	48 V DC	60 V DC	110 V DC	220 V DC	110 V AC	230 V AC
Motorised drive, spring force charging							
1. trip element "Off"							
2. trip element "Off"							
3. trip element "Off"							
trip element "On"							
electric closing lock-out							
Auxiliary voltages for drawer unit	24 V DC	48 V DC	60 V DC	110 V DC	220 V DC	110 V AC	230 V AC
motorised drive							
electro-mechanical interlocking							

Medium-voltage switchgear up to 17.5 kV, air-insulated, metal-clad, withdrawable technique, Type AMC

Delivery programme vacuum load-break switch drawer unit

Delivery programme vacuum load-break switch drawer unit

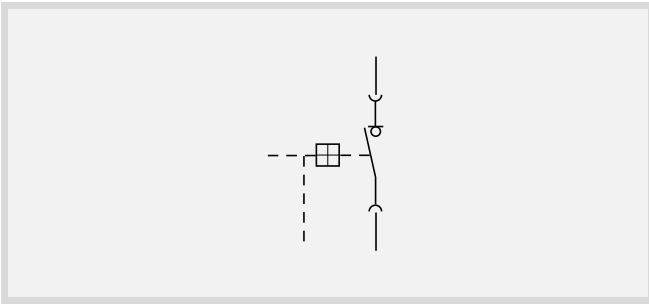

Load-break switch types ¹⁾	Installation in	Rated voltage U_r [kV]		
		7.2	12	17.5
NVLT2F-12/20/630-150C	AMC6	•	•	
NVLT2F-12/25/630-150C	AMC6	•	•	
NVLT2F-17/20/630-150C	AMC6			•
NVLT2F-17/25/630-150C	AMC6			•

1) Key to type references → page 9.

Technical data²⁾:

		Rated voltage U_r [kV]		
		7.2	12	17.5
Rated normal current I_r	A	630	630	630
Rated short-time current I_k , at $t_k = 3$ s	kA	20	20	20
	kA	25	25	25
Rated short-circuit making current I_{ma}	kA	50	50	50
	kA	62.5	62.5	62.5
Rated distribution line closed-loop breaking current I_{2a}	A	630	630	630
Rated no-load transformer breaking current I_3	A	6.3	6.3	6.3
Rated cable-charging breaking current I_{4a}	A	31.5	31.5	31.5
Rated earth-fault breaking current I_{6a}	A	630	630	630
Rated cable-charging breaking current under earth-fault conditions I_{6b}	A	31.5	31.5	31.5
Switching operations at I_{ma}		5 x		
Mechanical switching operations		5000 x		

2) Additional technical data → page 11.

Medium-voltage switchgear up to 17.5 kV, air-insulated, metal-clad, withdrawable technique, Type AMC

Equipment for vacuum load-break switch drawer unit

Equipment for vacuum load-break switch drawer unit

Equipment options for AMC vacuum load-break switch drawer units

Type: NVLT2F- 630-150C

Example: NVLT2F-12/20/630-150C

Standard equipment for load-break switch:

- charged spring drive "OFF" with manual actuation
- spring drive "ON" with manual actuation
- trip element "OFF"
- 64-pin plug connector with mechanical interlocking
- auxiliary contacts 5 NO + 5 NC (4 NO + 5 NC free available)
- fleeting contact witch annunciation "OFF"
- mechanical counter
- contact arms
- mechanical push- button "OFF"
- mechanical position indicator
- mechanical spring charge indicator

Additional equipment for load-break switch¹⁾:

- spring drive "ON" with motorised actuation
- undervoltage release, 100 V AC (non-delayed)
- auxiliary contact extension 5 NO + 5 NC
- electric closing lock-out

Standard equipment for drawer units:

- mechanical drawer movement, manual operation
- mechanical interlocking to the earthing switch
- mechanical push-button actuation for load-break switch push-button
- auxiliary contacts position "Disconnected position" 3 change-over contacts (2 free available)
- auxiliary contacts position "Connected position" 3 change-over contacts (2 free available)

Additional equipment for drawer unit¹⁾:

- motorised drive for drawer movement
- electro-mechanical interlocking for drawer movement

1) Further accessories on request

Auxiliary voltage for load-break switch	24 V DC	48 V DC	60 V DC	110 V DC	220 V DC	110 V AC	230 V AC
motorised drive, spring mechanism "ON"							
trip element "Off"							
electric closing lock-out							
Auxiliary voltages for drawer unit	24 V DC	48 V DC	60 V DC	110 V DC	220 V DC	110 V AC	230 V AC
motorised drive							
electro-mechanical interlocking							

Medium-voltage switchgear up to 17.5 kV, air-insulated, metal-clad, withdrawable technique, Type AMC

Delivery programme disconnecting link drawer unit

Delivery programme disconnecting link drawer unit

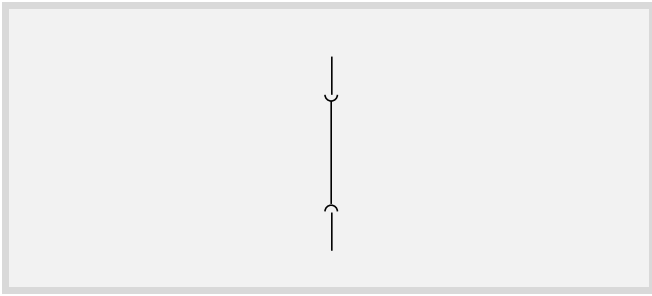

Technical data²⁾: optional

		Rated voltage U_r [kV]		
		7.2	12	17.5
Rated normal current I_r	A	630	630	630
	A	1250	1250	1250
	A	2500	2500	2000
Rated short-time current I_k , at $t_k = 3$ s	kA	20	20	20
	kA	25	25	25
	kA	31.5	31.5	31.5
Rated peak withstand current I_p	kA	50	50	50
	kA	62.5	62.5	62.5
	kA	80	80	80

2) Additional technical data → page 11.

Disconnecting link types ¹⁾	Installation in	Rated voltage U_r [kV]		
		7.2	12	17.5
NTB2F-12/20/630-150C	AMC6	•	•	
NTB2F-12/25/630-150C	AMC6	•	•	
NTB2F-12/31/630-150C	AMC6	•	•	
NTB2F-12/20/1250-150C	AMC6	•	•	
NTB2F-12/25/1250-150C	AMC6	•	•	
NTB2F-12/31/1250-150C	AMC6	•	•	
NTB2F-12/20/630-210C	AMC9	•	•	
NTB2F-12/25/630-210C	AMC9	•	•	
NTB2F-12/31/630-210C	AMC9	•	•	
NTB2F-12/20/1250-210C	AMC9	•	•	
NTB2F-12/25/1250-210C	AMC9	•	•	
NTB2F-12/31/1250-210C	AMC9	•	•	
NTB3F-12/20/2500-210C	AMC9	•	•	
NTB3F-12/25/2500-210C	AMC9	•	•	
NTB3F-12/31/2500-210C	AMC9	•	•	
NTB2F-17/20/630-150C	AMC6			•
NTB2F-17/25/630-150C	AMC6			•
NTB2F-17/31/630-150C	AMC6			•
NTB2F-17/20/1250-150C	AMC6			•
NTB2F-17/25/1250-150C	AMC6			•
NTB2F-17/31/1250-150C	AMC6			•
NTB2F-17/20/630-210C	AMC9			•
NTB2F-17/25/630-210C	AMC9			•
NTB2F-17/31/630-210C	AMC9			•
NTB2F-17/20/1250-210C	AMC9			•
NTB2F-17/25/1250-210C	AMC9			•
NTB2F-17/31/1250-210C	AMC9			•
NTB3F-17/20/2000-210C	AMC9			•
NTB3F-17/25/2000-210C	AMC9			•
NTB3F-17/31/2000-210C	AMC9			•

1) Key to type references → page 9.

Medium-voltage switchgear up to 17.5 kV, air-insulated, metal-clad, withdrawable technique, Type AMC
 Equipment for disconnecting link drawer unit

Equipment for disconnecting link drawer unit

Equipment options for AMC - disconnecting link drawer units

Type: NTB...F-..../..../.....-.....C

Example: NTB2F-12/25/1250-150C

- Standard equipment for disconnecting link:**
- contact arms
 - insulated busbar link

- Standard equipment for drawer units:**
- mechanical drawer movement, manual operation
 - mechanical interlocking to the earthing switch
 - electro-mechanical interlocking for the drawer movement
 - auxiliary contacts position "Disconnected position" 3 change-over contacts
 - auxiliary contacts position "Connected position" 3 change-over contacts

Auxiliary voltages for drawer unit	24 V DC	48 V DC	60 V DC	110 V DC	220 V DC	110 V AC	230 V AC
electro-mechanical interlocking							

Medium-voltage switchgear up to 17.5 kV, air-insulated, metal-clad, withdrawable technique, Type AMC

Delivery programme vacuum contactor drawer unit

Delivery programme vacuum contactor drawer unit

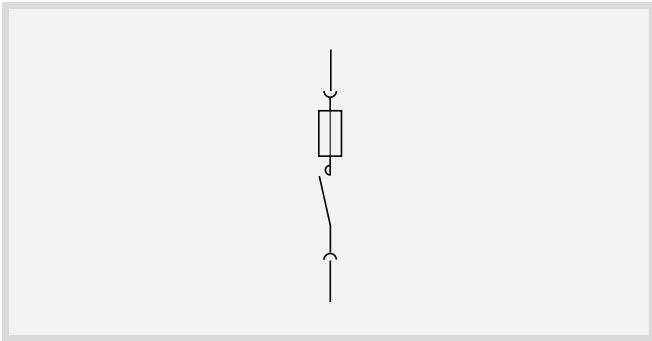

Contactor type ¹⁾	Installation in	Rated voltage U_r [kV]
NVSF-7/6/200-150C	AMC6	7.2 •

1) Key to type references → page 9.

Technical data²⁾:

		Rated voltage U_r [kV]
		7.2
Rated normal current I_e continuous current	A	200
Rated short-time current I_k	kA	Value is limited by HRC fuses.
Rated duration of short circuit t_k	s	1
Rated short-circuit breaking current I_{sc}	kA	50 ³⁾
Fuse dimension of HRC fuse "e"	mm	292
Rated maximum current for HRC fuse	A	355
Maximum switching operations per hour		300 X ⁴⁾
Switching operations at I_e (category AC3)		250000 X ⁴⁾
Mechanical switching operations		250000 X

2) Additional technical data → page 11.

3) Rated breaking current of the HRC fuse must be considered

4) Vacuum contactor with latched operating circuit

Medium-voltage switchgear up to 17.5 kV, air-insulated, metal-clad, withdrawable technique, Type AMC

Equipment for vacuum contactor drawer unit

Equipment for vacuum contactor drawer unit

Equipment options for AMC vacuum contactor drawer units

Type: NVSF-7/6/200-150C

Standard equipment for contactors:

- latched operating circuit
- closing coil "ON"
- trip coil "OFF"
- plug connector for control cable
- auxiliary contacts 3 NO + 3 NC (2 NO + 2 NC free available)
- mechanical counter
- contact arms
- mechanical position indicator

Standard equipment for drawer units:

- mechanical drawer movement, manual operation
- mechanical interlocking to the earthing switch
- auxiliary contacts position "Disconnected position" 3 change-over contacts (2 free available)
- auxiliary contacts position "Connected position" 3 change-over contacts (2 free available)

Additional equipment drawer unit:

- electro-mechanical interlocking for drawer movement

Auxiliary voltages for contactor	24 V DC	48 V DC	60 V DC	110 V DC	220 V DC	110 V AC	230 V AC
closing coil "ON"							
trip coil "OFF"							
Auxiliary voltages for drawer unit	24 V DC	48 V DC	60 V DC	110 V DC	220 V DC	110 V AC	230 V AC
electro-mechanical interlocking							

Medium-voltage switchgear up to 17.5 kV, air-insulated, metal-clad, withdrawable technique, Type AMC

Delivery programme earthing switch

Delivery programme earthing switch

Earthing switch, type EDL

Assembled as outgoing earthing switch at panel types -L, -LG, -K and -S.

Assembled as busbar earthing switch up to $I_k = 25$ kA in the panel extension above.

Earthing switch types	Installation at	Rated voltage U_r [kV]		
		7.2	12	17.5
EDL150/31	AMC6	•	•	•
EDL210/31	AMC9	•	•	•

Technical data²⁾:

		Rated voltage U_r [kV]		
		7.2	12	17.5
Rated short-time current I_k , at $t_k = 3$ s	kA	31.5	31.5	31.5
Rated short-circuit making current I_{ma}	kA	80	80	80
Switching operations at I_{ma}	5 x			
Mechanical switching operations	1000 x			
Class	E2			

2) Additional technical data → page 11.

Earthing switch type DES

Assembled as outgoing earthing switch in panel types AMC6-12/...-200-...-T and -M6.

Earthing switch type	Installation at	Rated voltage U_r [kV]	
		7.2	12
DES10/630-135	AMC6	•	•

Technical data²⁾:

Earthing switch type		Rated voltage U_r [kV]	
		7.2	12
Rated short-time current I_k , at $t_k = 1$ s	kA	20	20
Rated short-circuit making current I_{ma}	kA	50	50
Switching operations at I_{ma}	2 x		
Mechanical switching operations	1000 x		
Class	E1		

Medium-voltage switchgear up to 17.5 kV, air-insulated, metal-clad, withdrawable technique, Type AMC

Equipment for earthing switch

Equipment for earthing switch

Equipment options for AMC earthing switch

Type: EDL150/31
 EDL210/31
 DES10/630-135

Standard equipment for earthing switches:

- spring drive mechanism "ON"
- manual operation with position indicator

Additional equipment for earthing switches:

- motorised drive for actuation
- auxiliary contact extension 2 NO + 2 NC
- electro-mechanical interlocking

Auxiliary voltage for earthing switch	24 V DC	48 V DC	60 V DC	110 V DC	220 V DC	110 V AC	230 V AC
motorised drive							
electro-mechanical interlocking							

Medium-voltage switchgear up to 17.5 kV, air-insulated, metal-clad, withdrawable technique, Type AMC

Installation in the switchgear room

Installation in the switchgear room

Operating premises and intended use

The AMC switchgear can be used for indoors installations according to VDE 0101. At this juncture IEC 62271-200 (VDE 0671 part 200) and IEC 60694 (VDE 0670 part 1000) must be considered.

Equipment installation in the switchgear room

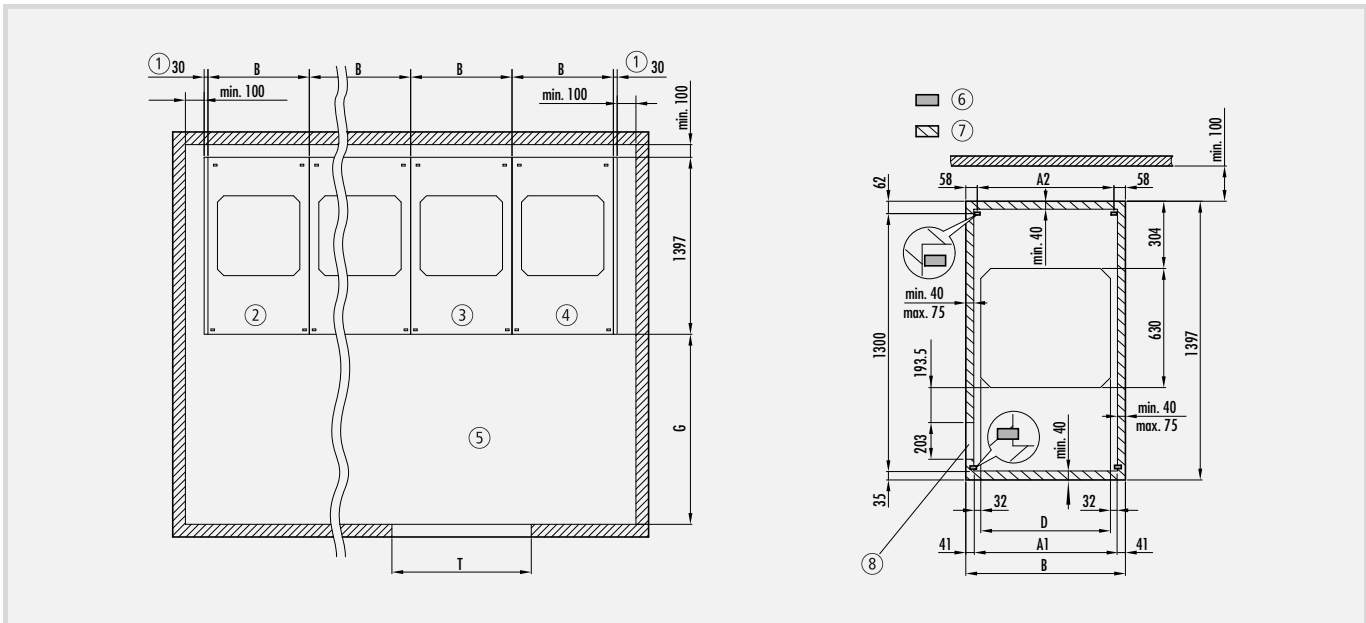

- ① End cassette
- ② Left end panel
- ③ Middle panel
- ④ Right end panel
- ⑤ Overall height of standard panel 2700 mm
- ⑥ Fastening bores 28 x 14
- ⑦ Floor contact area
- ⑧ Wiring duct

Panel width B	D	A1	A2
650	500	534	574
900	750	824	784

Dimensions in mm

Personnel safety

This AMC switchgear has been type-tested according to IEC 62271-200 (VDE 0671 part 200) arc-fault qualification IAC AFL.

The switchgear should be installed so that the greatest possible level of personnel safety is provided. In the standard version, pressure relief flaps on the top released in the event of an internal arc upwards.

To increase the personnel safety and to reduce the pressure in the switchgear room in the event of an internal arc, AMC switchgear can be equipped with arc absorber assemblies (standard equipment for $I_k = 31.5$ kA) instead of the pressure relief flaps. A further option with a pressure relief channel to exhaust the hot gases from the switchgear room is available. → page 6.

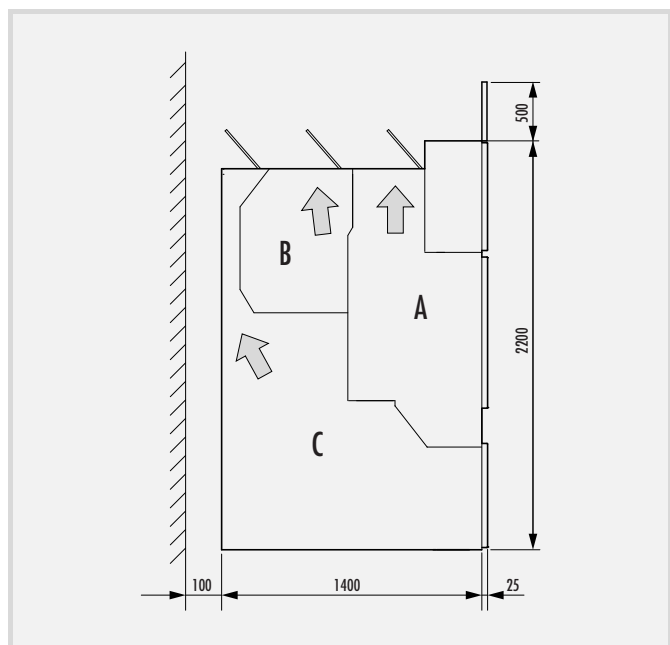

Medium-voltage switchgear up to 17.5 kV, air-insulated, metal-clad, withdrawable technique, Type AMC

Vacuum circuit-breaker

Vacuum circuit-breaker

Type NVL vacuum circuit-breaker

The vacuum circuit-breaker type NVL consists of the basic switch frame, the three switch poles and the switch mechanism.

The switch poles and switch mechanism are mounted on the basic switch frame.

The vacuum circuit-breaker type NVL is an Ormazabal product and is suitable for switching:

- Cables and overhead power lines
- Transformers
- Motors
- Generators

Vacuum circuit-breakers can also be used for the following switching functions:

- Synchronisation
- Short-time interruption.

Switch poles

The switch poles include the vacuum switching chamber with contact system, the contact pressure spring, the tripping spring, as well as cast-resin parts.

The cast-resin parts are for insulation, support and protection. In addition to their insulating function, they also absorb external forces from the switching process, contacting and short-circuit forces. They also provide mechanical protection for the vacuum chamber.

Switch mechanism

The switch mechanism is designed as a spring accumulator drive. The closing spring is charged by means of manual cranking or by motor. The operation can be done by manual push-buttons or by electrical trip elements. During the making process, the closing spring charges the contact pressure spring and closes the contacts. At the same time, the tripping springs are charged. To achieve operational capability short-time interruption, after the closing spring has been discharged it is recharged either manually or automatically if a motorised drive is mounted. By this means the necessary energy is stored for a short-time interruption, such as the switching sequence "OFF"- "ON"- "OFF".

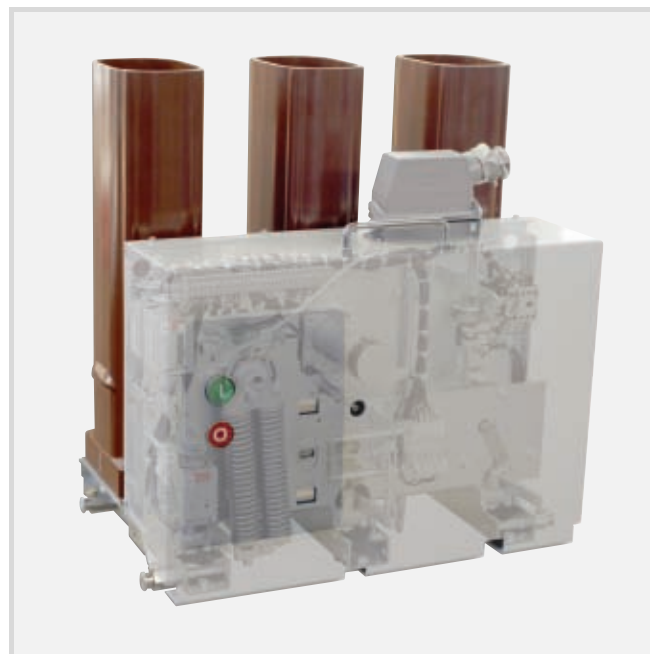

Vacuum circuit-breaker for rated voltages up to 17.5 kV

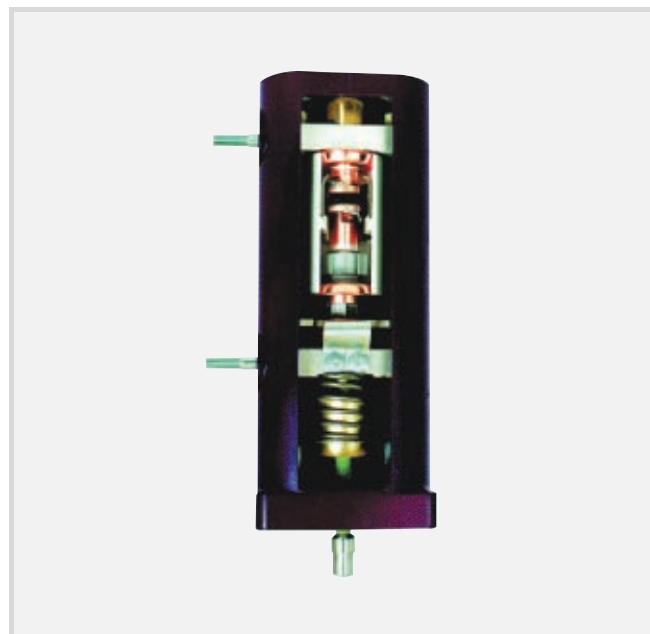

Switch pole with cast resin insulator and support

Medium-voltage switchgear up to 17.5 kV, air-insulated, metal-clad, withdrawable technique, Type AMC

Capacitive voltage detection system

Capacitive voltage detection system

Capacitive voltage detection system

For hazard-free detection of the operating voltage, the panels can optionally be equipped with capacitive voltage detection systems according to IEC 61243-5. There are two installation positions available for the capacitive insulators:

- at the main busbar
- at the outgoing busbars (→ page 7)

The indication is funded by a continuous voltage detection system according to IEC 61243-5 with the necessary interfaces placed at the door of the low voltage compartment.

The visualisation is designed separately for each phase, for example by high-intensity LEDs.

A phase comparator can be connected for checking the phase sequence.

Version examples:

Type: CPI VI-3P (standard version)

- no auxiliary voltage required

Type: CPI VI-3P/R - with relay output 2 W (change-over contact)
(max. AC 230 V, 3 A)

- auxiliary voltages
DC: 48 V, 60 V, 110 V, 220 V
AC: 110 V, 230 V

Indication range according to IEC 61243-5

$U_0 < 10\% U_N$ = no voltage present

$U_0 > 45\% U_N$ = voltage present



Capacitive detection system in the door of the low voltage compartment

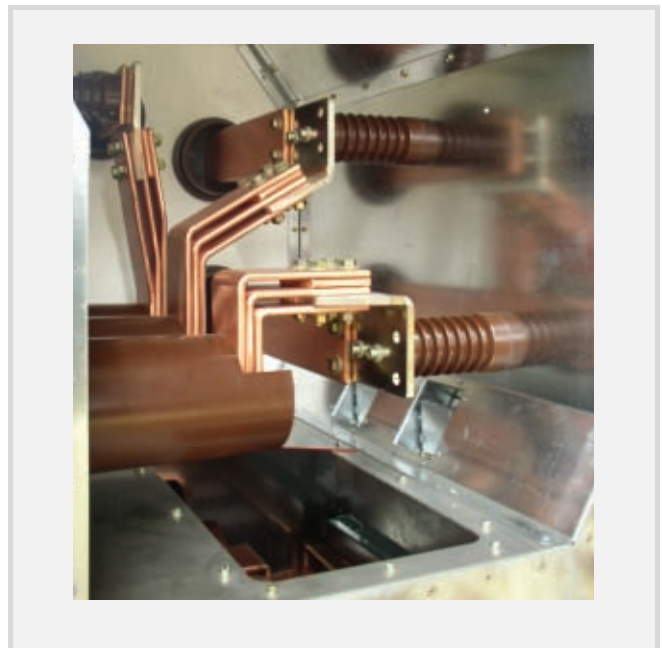

Busbar compartment with capacitive insulators

Medium-voltage switchgear up to 17.5 kV, air-insulated, metal-clad, withdrawable technique, Type AMC

Switchgear accessories

Switchgear accessories

Busbar earthing drawer unit

Optional busbar earthing drawer units in the drawer unit compartment of the panel can be used for earthing main busbar sections in installations.

This requires only that the drawer unit compartment is equipped with a standard drawer unit and the option "panel connection bolt" → page 13.

Busbar earthing drawer unit type	Installation at	Rated voltage U_r [kV]		
		7.2	12	17.5
NSE2F-17/31-150C	AMC6	•	•	•
NSE2F-17/31-210C ¹⁾	AMC9	•	•	•
NSE3F-17/31-210C ²⁾	AMC9	•	•	•

1) For AMC9 panels with outgoing busbars up to 1250 A

2) For AMC9 panels with outgoing busbars up to 2500 A

Auxiliary carriage

An auxiliary carriage serves the purpose of inserting and removing of the drawer units. It can be adjusted to match the height of the panel and compensate for unevenness at the floor. The interlocking of the drawer unit to the auxiliary carriage, locking bolts to fix the carriage on the switchgear panel and move-in guides to the rails in the drawer unit compartment ensure user-friendly and safe operation.



Operating levers

The following levers are provided for operation:

- ① Manual crank handle for the spring accumulator of the switch
- ② Manual crank handle for moving the drawer units
- ③ Switching lever for manual actuation of the earthing switch
- ④ Fastener key for manual actuation of the switchgear drawer units in connected position and for interlocking the front doors
- ⑤ Emergency crank handle for motorised earthing switch (optional)

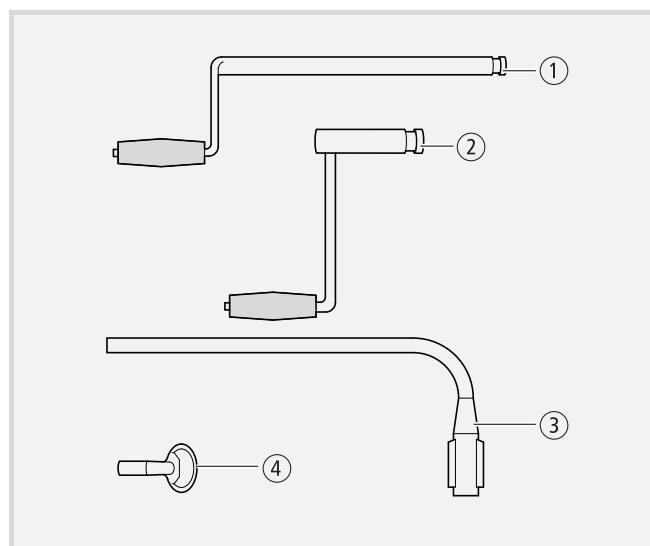

Medium-voltage switchgear up to 17.5 kV, air-insulated, metal-clad, withdrawable technique, Type AMC

Protection technology

Protection technology

Protection and control systems

Type AMC switchgear is used a very wide range of areas in power distribution and mostly includes comprehensive protection and control systems to provide the related functions for the application. Conventional protection devices up to complex combinations of protection and control systems are used. The devices are installed in the low-voltage compartment for the panels. Indicators and controls are integrated into the front door of the low voltage compartment.

Functionality (optional)

- Control system (switch elements)
- Measurement and analysis
- Communication interfaces
- Indication of the switch positions
- Sequence of events recorder function
- Programmable logic functions
- On-site parameter configuration
- Protection functions such as
 - Differential protection
 - Distance protection
 - Overcurrent time protection
 - Earth fault protection
 - Overload protection
 - Over/under voltage protection
 - Over/under frequency protection
 - Directional power protection
 - Load unbalance protection
 - Automatic re-starting
 - etc.

Communication

A wide range of interfaces and protocol structures are available for communication with the control system depending on the device variants used. The connection is made using a data cable or fibre optic cable depending on the system.

Interfaces (system dependent):
RS232, RS485, CAN bus, etc.

Data protocols (system dependent):
IEC 60870-5-103, IEC 60870-5-101,
IEC 61850, Profibus DP or Modbus etc.

A few commercially available protection relays as examples:

- SEG type CSP/CMP
- Siemens type 7SJ63
- ABB type REF542plus
- Areva type P139

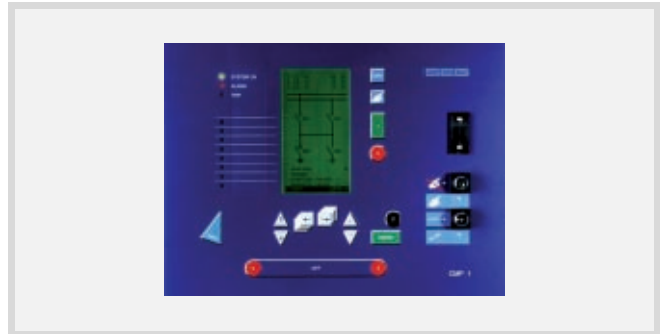

SEG type CSP/CMP



Siemens type 7SJ63



ABB type REF542plus

Notes

Notes



ORMAZABAL

Technical-Commercial Department

Tel.: +34 94 431 87 31

Fax: +34 94 431 87 32

E-Mail: oib@ormazabal.com

www.ormazabal.com

SF₆-insulated switchgear

- type GA
- type GAE
- type CPG.0
- type CPG.1

Air-insulated switchgear

- type EA
- type AMC

Air-insulated switches

- type NVL
- type KL(F), T, DES

